

## Introducing Your Device

Learn about your device's layout, indications and specifications.

### 1. Inside the Box

Check your product box for the following items:

- ▶ Device
- ▶ Charging cable
- ▶ Relay
- ▶ Relay socket
- ▶ User manual

### 2. Overview

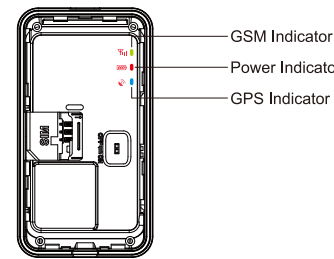

### LED Indications

| Power indicator (red)                           | Indication               |
|---|--------------------------|
| Quick Flashing (flash 0.3s at interval of 0.3s) | Low battery              |
| Solid red                                       | Charging                 |
| Flashing (flash 1s at interval of 3s)           | Full charge              |
| OFF   | Power off or low battery |
| Slow flashing (flash 0.1s at interval of 3s)    | Working normally         |

| GPS indicator (blue)                         | Indication                  |
|--|-----------------------------|
| Flashing (ON:0.35, OFF:0.35)                 | Searching GPS signal        |
| Slow flashing (flash 0.1s at interval of 3s) | Receive GPS signal normally |
| OFF  | No GPS signal               |

| GSM indicator (green)                           | Indication                   |
|---|------------------------------|
| Quick Flashing (flash 0.3s at interval of 0.3s) | GSM initializing             |
| Flashing (flash 1s at interval of 3s)           | Receive GSM signal normally  |
| Solid green                                     | In communication with phones |
| OFF   | No GSM signal or no SIM card |
| Slow flashing (flash 0.1s at interval of 3s)    | GPRS on line                 |

### 3. Specifications

|                 |                                |
|-----------------|--------------------------------|
| Dimension       | 78.0(L) x 41.0(W) x 13.0(H) mm |
| Weight          | 38g                            |
| Working voltage | 9-90V                          |
| Backup Battery  | 270mAh / 3.7V                  |

|                         |   |
|-------------------------|---|
| Operation Temperature   | -20°C - 70°C                                      |
| Humidity                | 20% - 80%   |
| Standby Time            | 60 hours  |
| GSM Frequencies         | 850/900/1800/1900 MHz                             |
| GPRS                    | Class 12, TCP/IP                                  |
| GPS Channel             | 32  |
| GPS Sensitivity         | -162dBm   |
| Acquisition Sensitivity | -148dBm   |
| Position Accuracy       | < 10m   |
| TTF (Open Sky)          | Cold Start: < 35s<br>Hot Start: < 1s              |
| GSM/GPS Antenna         | Built-in design                                   |
| LED Indicator           | GSM-green, GPS-blue, Power-red                    |
| Data Transmit           | TCP SMS   |
| Geo-fence Alarm         | Alarm when get in or get out a specified area     |
| Speeding Alarm          | Report when speeds higher than the pre-set value. |
| Low Power Alarm         | Alarm when backup battery is running out          |
| Non-movement Detection  | Movement alarm based on built-in 3D motion sensor |
| Mileage Report          | Track by time/distance interval                   |
| Remote Control          | Cut off petrol/electricity                        |

## 4. Getting Started

### 4.1 Switch on

Get started by assembling and setting up your device for its first use.

1. Open the SIM card cover.

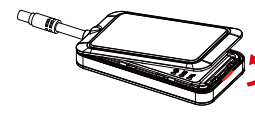

2. Insert the SIM card.



NOTE:  
SIM card should be equipped with GPRS and SMS functions.

3. Turn the battery switch to ON.

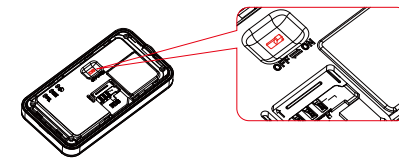

4. Close the SIM card cover and connect the device with the external power line which will be used to charge the terminal and built-in battery.

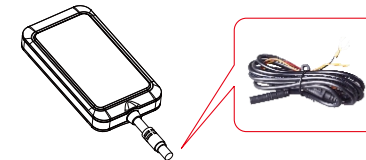

### 4.2 Switch off

1. Toggle the battery switch to OFF.

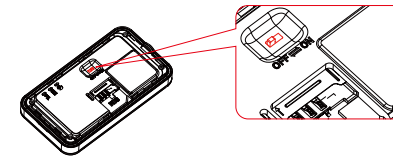

### 4.3 Charge the device

Plug the device connector into a charging cable.

The charging cable with 1A FUSE for short-circuit over current protection.

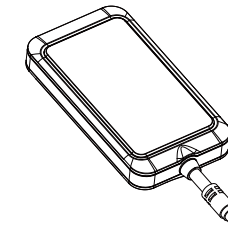

### NOTE:

Improperly connecting the charging cable can cause serious damage to the device. Any damages by misuse are not covered by the warranty.

### 4.4 Install the device

You need to choose somewhere that it won't be found.

- Your device has built-in GSM antenna and GPS antenna. During installation, please make sure the receiving side face is up; any high power devices such as reversing radar, anti-theft device or communication equipment would affect the signal of the device.
- All metallic cases of the windshield will attenuate the signal on the tracking device. It's simply due to the shielding effects of the metal compound of the case.
- The device should be fixed into position with cable ties or wide double-side tape.

Installation please refers to below picture.

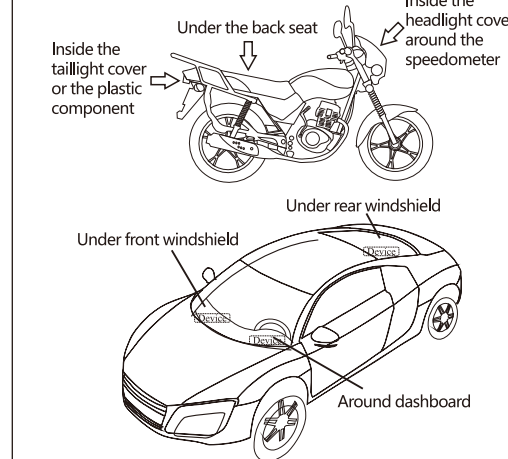

- Under the dash board below the front windshield;
- In the parcel shelf in the rear;
- In the front bumper (non-material face), make sure the device does not get wet;
- Under the wiper version (non-metal), make sure the device does not get wet;
- Non Covert Installation - fix the device on the dash board below windshield.

### Device Wiring

- Since the recharging voltage can be much higher than the working voltage, for your safety, please use with vehicle battery voltage no more than 72V. The red wire is

- the positive, the black wire is the negative.
- Connect the black wire to ground.

### 4.5 Device wiring diagram

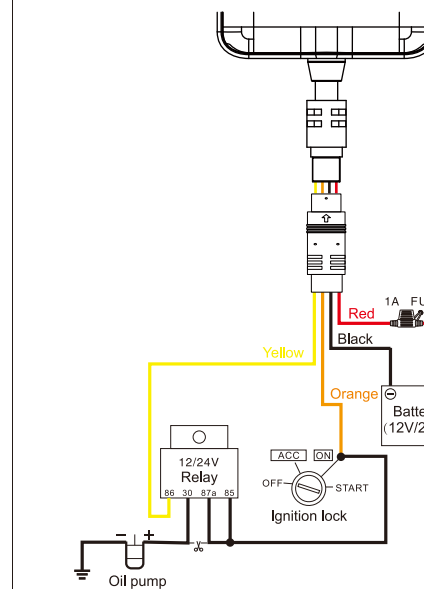

NOTE:  
Please pay attention to the diagram description, battery is no more than 72V and relay remains 12V / 24V.

### 4.6 Power/ACC/Tele-cutoff (petrol/electricity) control line (4 pin)

- Your device comes with a power cord and is designed to use only manufacturer-specified original device. The red line is positive while the black one is negative (the side should not be connected with ground wire).
- The ACC line (orange) connects to ACC switch of the vehicle. Please be sure to connect the ACC line; otherwise the device won't enter ignition detection status when disconnect the ACC line. If you don't need to anti-theft temporarily, just connect the ACC line to the positive side in parallel.
- Tele-cutoff (petrol/ electricity) control line (yellow) is connected to pin 86 of the Tele-cutoff (petrol/ electricity) relay (equal to the yellow line of the relay socket).

### 5. Quick Operation Instructions

To properly use the device, common parameters should be set before initial use. This can be done by using the parameter editor or by sending SMS commands to the device. ("," should be English comma and no space before and after the comma)

### 5.1 Add SOS number

SMS command to the device to add the SOS number.

**SOS,A,No.1,No.2,No.3#**

"A" means to add new numbers, for example:

**SOS,A,18165542975,18165542976,18165542977#**

It will reply

**"OK! SOS1: 18165542975 SOS2: 18165542976 SOS3: 18165542977"**

after set successfully.

### 5.2 APN setting

To ensure GPRS is activated, please make sure APN is correct. You can send SMS command to set APN: APN command format: **APN,APN's Name#** E.g: APNinternet# ("internet" is the APN of carrier) The device will reply "OK" if setting successfully.

Note: The APN of some countries have user name and password, you may need to send SMS command as following: **APN,APN name,user name,password#**

### 5.3 Server setting

Default platform is [www.tracksolid.com](http://www.tracksolid.com)

To connect to other platform, please send the SMS command to change the DNS or server IP:

DNS : **SERVER,1,DNS,Port,0#**

E.g: **SERVER,1,gpsdev.tracksolid.com,21100,0#**

IP: **SERVER,0,IP,Port,0#**

It will reply "OK" after set successfully.

### 5.4 Set the center number

If you want to cut off/restore oil by SMS command, you have to set a center number firstly. Only the center number can send the cut off/restore oil command to the device. You can set your own mobile number as center number.

The command for setting center number is:

**CENTER,A,mobile number#**

E.g. **CENTER,A,18165542976#**

If set successfully, there is an "OK" reply message.

### NOTE:

Only the SOS number can be used to add or delete center number successfully. There is only one center number can be set.

### 5.5 Locator Data Upload Interval

Users can modify GPRS uploading time interval by SMS

**TIMER,T1,T2#**

T1 ranges 5~18000 or 0(seconds), upload interval when

ACC ON, 0 means no upload, default is 20;

T2 ranges 5~18000 or 0(seconds), upload interval when

ACC OFF, 0 means no upload, default is 20.

### 5.6 Arming time setting

Delay time for device entering arming state after the vehicle power is off and ACC is in low-level. In the arming state, if the vehicle vibrates for a few times, it will activate the vibration alarm system. If the vehicle battery is still not on (ACC is in low level) after 3 minutes, the device will start vibration alarm.

SMS format:

**DEFENSE,TIME#**

The time ranges from 1 to 60 minutes, default is 1.

### NOTE:

1. Preset SOS numbers before sending SMS alarm

messages and calls.

2. If there is no need for vibration alarm, please SMS

**SENALM,OFF#** to close it.

### 5.7 Check parameter setting

You can check the parameter setting by command:

**PARAM#**

Example: **PARAM#**

Information replied:

IMEI:358735070292023; TIMER:20,20; SENDS:3; SOS:;;

Center Number;; Sensorset:10,3,5,1; Defense time:1;

TimeZone:E,8,0;

The replied information contains IMEI number, GPS data

uploading Interval, GPS working time, SOS number,

center number, sensor time interval, defense time and time zone info.

### 5.8 Check GPRS parameters

SMS command format :

**GPRSET#**

Example: **GPRSET#**

Reply message:

GPRS:ON; Currently use APN:cmmtm,; Server:1;

GPSDEV.TRACKSOLID.COM,21100,0;

URL:http://maps.google.com/maps?q=;

## 6. Operation of device

### 6.1 Power on/ Power off

Power on: Once insert a valid SIM card and connect all the wires, turn on the device, then Power LED will flash first, during signal searching process, GSM and GPS LED will flash. Once GPS LED keeps slow flashing, it means the device has been located and it starts to work.

Power off: Just turn off the power switch.

The device will begin to upload positioning data to server

once inserting a valid SIM card and power on. During the

working time, it can upload data to server every 10

seconds.

### NOTE:

To power on / power off, please remove the back cover

first, refer to **4. Getting Started**.

### 6.2 Check location

#### 1. Via SMS

1,1 SMS **"WHERE#"** to the SIM number of device. The

device will send a location message automatically. You

can get the coordinates. If the device does not search any information of location, it will send "No data" to the cell phone.

Example:

Current position!

Lat:N22.577156, Lon:E113.916748, Course:131.99, Speed:0.

00Km/h, Date

Time:2013-10-08 17:35:32

1,2 SMS **"URL#"** to the SIM number of device. The device

will send a location Google Map link. If the device does

not search any information of location, it will send "No

data" to the cell phone.

Example:

<10-08

17:36>http://maps.google.com/maps?q=N22.577156,E1

13.916748

#### 2. Via platform

Go to the platform website offered by dealers to check

your vehicle location.

#### 6.3 Wire cut-off alarm

When the electricity supply of device is cut off, it will

activate cut-off alarm. In this case, the device will send

related SMS to the SOS numbers and dial the numbers in

circles. If nobody answers, the call just keeps 3 loops at

most. At the meantime, the device will upload power cut

off alarm data to the server. And it will send:

Cut Power ! <Date Time:13-06-17 14 : 53 : 06>;

http://maps.google.com/maps?q=N22576713,E113.9165

85

### NOTE:

The SOS numbers should be preset, please refer to **5.1**.

### 6.4 Low battery alarm

When the device is only working with battery, once the internal voltage of battery is less than 3.7V, device will send low battery alarm SMS to SOS number and alarm on platform.

Low battery alarm SMS content

example:"Attention!!!Battery is too low, please charge."

Which means the battery is too low, inform user charging

it in time.

### NOTE:

The SOS numbers should be preset, please refer to **5.1**.

### 6.5 Vibration alarm

The vibration alarm function is off by default. To activate

this function, please send the following command:

**SENALM, ON#**

ACC OFF & in arming state

If 5 times (times can be set) of vibration detected in 10

seconds, 1) ACC OFF in the following 30 seconds, the

device will send vibration alarm. 2) ACC ON in within 30

seconds, no vibration alarm will be triggered.

### NOTE:

1. The SOS numbers should be preset.

2. Send "SENALM, OFF#" to turn off the vibration alarm

if don't need.

### 6.6 Oil cut-off

#### 1. via platform

Send oil cut-off command on platform. To make sure the

security of vehicle, tracker can only indicate to cut off oil

when GPS is in valid position status, and the speed is less than 20KM/H or in static. Platform account password is needed when sending oil cut off command.

#### 2. Via SMS

Firstly, you should set a center number. Please refer to **5.4**.

Only center number can send the command to the device

to cut off and restore oil.

The format is: **RELAY,1#**

After the command is carried out, it will reply "Cut off the

fuel supply: Success! Speed:0 Km/h". If the command

didn't carry out, it will reply the reason about fail to carry

out.

### NOTE:

To ensure the safety of the driver and the car, this

command is valid only under two conditions: the GPS is

located; the speed is less than 20km/h.

### 6.7 Restoring Oil

#### 1. Via platform

When the alarm is off, sending recover oil commands

manually. Device will restore oil supplying, and vehicle will

work normally again.

Platform account password is needed when sending oil

cut off command.

#### 2. Via SMS

Only center number can send the command to the device

to restore oil.

The format is: **RELAY,0#**

After the command is carried out, it will receive "Restore

fuel supply: Success!"

### 6.8 Over Speed Alarm

When the car is moving over a limited speed in average in a limited time period, then the device will send over speed alarm SMS to user.

To turn on the over speed function, please send below

SMS command:

**SPEED,ON,Time,Limited speed,way of alarm#**