



FMB900 User Manual

V0.24

Table of contents

1	INTRODUCTION	7
1.1	ATTENTION.....	7
1.2	INSTRUCTIONS OF SAFETY	7
1.3	LEGAL NOTICE	8
1.4	ABOUT DOCUMENT	8
2	BASIC DESCRIPTION	8
2.1	BASIC CHARACTERISTICS	9
2.2	TECHNICAL FEATURES.....	10
2.3	ELECTRICAL CHARACTERISTICS.....	11
2.4	ABSOLUTE MAXIMUM RATINGS.....	12
3	CONNECTION, PINOUT, ACCESSORIES.....	13
3.1	HOW TO INSERT SIM CARD INTO FMB900 DEVICE:	13
3.2	HOW TO ADD MICROSD CARD INTO FMB9XX DEVICE	13
3.3	INSTALLING FMB900 DRIVERS	14
3.4	ACCESSORIES.....	16
3.5	TERMINAL LOG FOR FMB DEVICES.....	18
3.6	NAVIGATE LED.....	19
3.7	STATUS LED	19
4	OPERATIONAL BASICS.....	20
4.1	OPERATIONAL PRINCIPALS.....	20
4.2	SLEEP MODES.....	20
4.2.1	<i>Sleep mode</i>	20
4.2.2	<i>Deep Sleep mode</i>	20
4.3	VIRTUAL ODOMETER.....	21
4.4	FEATURES.....	22
4.4.1	<i>ECO driving/Green driving Scenarios</i>	22
4.4.2	<i>Over Speeding Scenario</i>	22
4.4.3	<i>Excessive Idling</i>	23
4.4.4	<i>Jamming detection</i>	23
4.4.5	<i>Trip</i>	23
4.4.6	<i>DOUT Control Via Call</i>	23
4.5	GPS FUEL CONSUMPTION	23
4.6	SCENARIOS ACCELEROMETER.....	23
4.6.1	<i>Towing Detection</i>	23
4.6.2	<i>Crash Detection</i>	23
4.7	BLUETOOTH.....	23
5	CONFIGURATION	24
5.1	CONFIGURATOR.....	24
5.2	SYSTEM SETTINGS.....	26
5.3	RECORDS SETTINGS.....	28
5.4	GSM SETTINGS, GPRS PART.....	28
5.5	GSM SETTINGS, SMS/CALL PART	29
5.6	GSM SETTINGS, OPERATOR LIST	31
5.7	DATA ACQUISITION MODE SETTINGS	31
5.8	FEATURES SETTINGS.....	35
5.8.1	<i>Eco/Green Driving</i>	35
5.8.1.1	<i>Data output</i>	36
5.8.1.2	<i>Auto Calibaration</i>	36
5.8.2	<i>Over Speeding</i>	37
5.8.3	<i>Excessive Idling</i>	37

5.8.4	<i>Jamming</i>	37
5.8.5	<i>DOUT control via call</i>	37
5.8.6	<i>Trip settings</i>	37
5.9	AUTOGEOFENCING SETTINGS	38
5.10	GPS FUEL COUNTER.....	39
5.11	SCENARIOS ACCELEROMETER.....	40
5.11.1	<i>Towing Detection</i>	40
5.11.2	<i>Crash Detection</i>	41
5.12	BLUETOOTH.....	42
5.13	HOW TO CONNECT BLUETOOTH HANDS FREE ADAPTER TO FMB DEVICE	45
5.13.1	<i>Bluetooth settings configuration</i>	45
5.13.2	<i>Connecting Bluetooth Hands Free adapter</i>	47
5.14	DEVICE'S LOG USING YOUR MOBILE PHONE.....	47
5.15	DEVICE DEBUG OVER ANDROID SMARTPHONE.....	48
5.16	HOW TO CONNECT OBD II BLUETOOTH DONGLE TO FMB DEVICE.....	50
5.16.1	<i>Bluetooth settings configuration</i>	50
5.16.2	<i>Connecting to Bluetooth OBD II dongle</i>	52
5.16.3	<i>Supported Bluetooth OBD II dongles</i>	52
5.17	SMS EVENTS.....	53
5.18	I/O SETTINGS	55
6	SMS COMMAND LIST	56
6.1	SMS COMMAND LIST.....	56
6.1.1	<i>getinfo</i>	57
6.1.2	<i>getver</i>	58
6.1.3	<i>getstatus</i>	58
6.1.4	<i>getgps</i>	59
6.1.5	<i>ggps</i>	59
6.1.6	<i>radio #</i>	59
6.1.7	<i>getparam</i>	59
6.1.8	<i>setparam</i>	59
6.1.9	<i>flush #,#,#,#,#,#</i>	60
6.1.10	<i>setdigout</i>	60
6.1.11	<i>countrecs</i>	60
6.1.12	<i>towingreact</i>	60
6.1.13	<i>btgetlist</i>	61
6.2	SYSTEM PARAMETERS	61
6.2.1	<i>Sleep Mode (ID=102)</i>	61
6.2.2	<i>Sleep timeout (ID=103)</i>	61
6.2.3	<i>Movement Source (ID=100)</i>	61
6.2.4	<i>Static Navigation (ID=106)</i>	61
6.2.5	<i>Saving/Sending without time synchronization (ID=107)</i>	62
6.2.6	<i>GNSS Source (ID=109)</i>	62
6.2.7	<i>Ignition settings (ID=101)</i>	62
6.2.8	<i>High voltage level (ID=104)</i>	62
6.2.9	<i>Low voltage level (ID=105)</i>	63
6.2.10	<i>Led indication (ID=108)</i>	63
6.2.11	<i>Synchronization settings (ID=900)</i>	63
6.2.12	<i>NTP Resync (ID=901)</i>	63
6.2.13	<i>NTP server 1 (ID=902)</i>	63
6.2.14	<i>NTP server 2 (ID=903)</i>	63
6.3	RECORDS PARAMETERS	63
6.3.1	<i>Sorting (ID=1002)</i>	63
6.3.2	<i>Open Link Timeout (ID=1000)</i>	64
6.3.3	<i>Server Response Timeout (ID=1001)</i>	64
6.4	GSM PARAMETERS	64
6.4.1	<i>GPRS content activation (ID=2000)</i>	64
6.4.2	<i>APN Name (ID=2001)</i>	64

6.4.3	APN username (ID=2002)	65
6.4.4	APN Password (ID=2003)	65
6.4.5	Domain (ID=2004)	65
6.4.6	Target Server Port (ID=2005)	65
6.4.7	Protocol (ID=2006)	66
6.5	SMS/CALL SETTINGS	66
6.5.1	SMS data sending settings (ID=3000)	66
6.5.2	Data send number (ID=3001)	66
6.5.3	Authorized phone numbers (ID=4000-4009)	66
6.5.4	SMS Event Predefined Numbers (ID=6000-6009)	66
6.5.5	SMS Login (ID=3003)	66
6.5.6	SMS Password (ID=3004)	67
6.5.7	Incoming call action (ID=3005)	67
6.5.8	Outgoing Call Trigger (ID=3007)	67
6.5.9	GSM number index (ID=3008)	67
6.5.10	Operator List (ID=5000-5049)	67
6.6	DATA ACQUISITION MODES PARAMETERS	67
6.6.1	Home Network GSM operator code "Vehicle on STOP" parameters	67
6.6.1.1	Min Period (ID=10000)	67
6.6.1.2	Min Saved Records (ID=10004)	68
6.6.1.3	Send Period (ID=10005)	68
6.6.2	Home Network GSM operator code "Vehicle MOVING" parameters	68
6.6.2.1	Min Period (ID=10050)	68
6.6.2.2	Min Distance (ID=10051)	68
6.6.2.3	Min Angle (ID=10052)	68
6.6.2.4	Min Speed delta (ID=10053)	69
6.6.2.5	Min Saved Records (ID=10054)	69
6.6.2.6	Send Period (ID=10055)	69
6.6.3	Roaming Network GSM operator code "Vehicle on STOP" parameters	69
6.6.3.1	Min Period (ID=10100)	69
6.6.3.2	Min Saved Records (ID=10104)	69
6.6.3.3	Send Period (ID=10105)	70
6.6.4	Roaming Network GSM operator code "Vehicle MOVING" parameters	70
6.6.4.1	Min Period (ID=10150)	70
6.6.4.2	Min Distance (ID=10151)	70
	Min Period (ID=10150)	70
6.6.4.3	Min Angle (ID=10152)	70
6.6.4.4	Min Speed (ID=10153)	70
6.6.4.5	Min Saved Records (ID=10154)	71
6.6.4.6	Send Period (ID=10155)	71
6.6.5	Unknown Network GSM operator code "Vehicle on STOP" parameters	71
6.6.5.1	Min Period (ID=10200)	71
6.6.5.2	Min Saved Records (ID=10204)	71
6.6.5.3	Send Period (ID=10205)	71
6.6.6	Unknown Network GSM operator code "Vehicle MOVING" parameters	72
6.6.6.1	Min Period (ID=10250)	72
6.6.6.2	Min Distance (ID=10251)	72
6.6.6.3	Min Angle (ID=10252)	72
6.6.6.4	Min Speed (ID=10253)	72
6.6.6.5	Min Saved Records (ID=10254)	72
6.6.6.6	Send Period (ID=10255)	73
6.7	FEATURES PARAMETERS	73
6.7.1	Green driving priority (ID=11000)	73
6.7.2	Max Acceleration Force (ID=11004)	73
6.7.3	Max Braking Force (ID=11005)	73
6.7.4	Max Cornering (ID=11006)	73
6.7.5	Green/Eco driving (ID=11007)	73
6.7.6	Green driving digital output control settings (ID=11003)	74
6.7.7	Green driving Digital output on duration (ID=11001)	74
6.7.8	Green driving Digital output off duration (ID=11002)	74

6.7.9	Overspeeding priority (ID=11100)	74
6.7.10	Max allowed Speed (ID=11104).....	74
6.7.11	Overspeeding output control (ID=11103)	74
6.7.12	Overspeeding Digital output on duration (ID=11101)	75
6.7.13	Overspeeding Digital output off duration (ID=11102).....	75
6.7.14	Excessive idling priority (ID=11200).....	75
6.7.15	Eventual records (ID=11203)	75
6.7.16	Excessive idling minimum stop duration (ID=11205).....	75
6.7.17	Excessive idling minimum move duration (ID=11206).....	75
6.7.18	Excessive idling output control (ID=11204)	75
6.7.19	Excessive idling output on duration (ID=11201).....	76
6.7.20	Excessive idling output off duration (ID=11202).....	76
6.7.21	Send sms to (ID=7064).....	76
6.7.22	SMS Text (ID=8064)	76
6.7.23	Jamming (ID=11300)	76
6.7.24	Jamming Eventual records (ID=11303).....	76
6.7.25	Jamming Output Control (ID=11304)	77
6.7.26	Jamming DOUT on duration [ms] (ID=11301)	77
6.7.27	Jamming DOUT off duration [ms] (ID=11302).....	77
6.7.28	DOUT control via call (ID=12000).....	77
6.7.29	DOUT deactivation settings (ID=12001).....	77
6.7.30	DOUT duration timeout [s] (ID=12002)	77
6.7.31	Trip priority priority (ID=11800)	78
6.7.32	Start Speed (ID=11803).....	78
6.7.33	Ignition Off Timeout (ID=11804).....	78
6.7.34	Trip mode (ID=11802).....	78
6.8	AUTOGEOFENCING.....	78
6.8.1.1	AutoGeofencing priority (ID=20000)	78
6.8.1.2	Eventual Records (ID=20002).....	79
6.8.1.3	Activation Timeout (ID=20003)	79
6.8.1.4	Deactivate by (ID=20005)	79
6.8.1.5	AutoGeofence event generating (ID=20001)	79
6.8.1.6	Radius (ID=20004).....	79
6.8.1.7	Send sms to (ID=7061)	79
6.8.1.8	SMS Text (ID=8061).....	80
6.9	GPS FUEL COUNTER	80
6.9.1.1	City Consumption L/100km (ID=11900)	80
6.9.1.2	Highway Consumption L/100km (ID=11901).....	80
6.9.1.3	Average Consumption L/100km (ID=11902)	80
6.9.1.4	City Speed [km/h] (ID=11903)	80
6.9.1.5	Highway Speed [km/h] (ID=11904)	80
6.9.1.6	Average Speed [km/h] (ID=11905)	80
6.9.1.7	Correction coefficient (ID=11906)	81
6.9.1.8	Fuel Consumption on Idling [L/h] (ID=11907)	81
6.9.1.9	Higher Speeds Add [%] (ID=11908).....	81
6.9.1.10	Highway Consumption every km/h (ID=11909)	81
6.10	SCENARIOS ACCELEROMETER.....	81
6.10.1	Towing Detection.....	81
6.10.1.1	Scenario setting (ID=11600).....	81
6.10.1.2	Eventual Records (ID=11601).....	81
6.10.1.3	Activation Timeout (min) (ID=11602)	81
6.10.1.4	Event Timeout (s) (ID=11603)	82
6.10.1.5	Make Call(Sms Event Number ID) (ID=11604)	82
6.10.1.6	Threshold (mg) (ID=11605).....	82
6.10.1.7	Angle (deg) (ID=11606).....	82
6.10.1.8	Duration (msec) (ID=11607)	82
6.10.1.9	Send SMS (ID=7066)	82
6.10.1.10	SMS Text (ID=8066)	82
6.10.2	Crash Detection	83
6.10.2.1	Scenario settings (ID=11400).....	83
6.10.2.2	Duration [ms] (ID=11401).....	83

6.10.2.3	Treshold [mG] (ID=11402)	83
6.10.2.4	Crash trace (ID=11406)	83
6.10.2.5	Send sms to (ID=7068)	83
6.10.2.6	SMS Text (ID=8068)	83
6.11	BLUETOOTH	83
6.11.1.1	BT Radio (ID=800)	83
6.11.1.2	Local name (ID 801)	83
6.11.1.3	Local PIN (ID=802)	84
6.11.1.4	Security mode (ID=803)	84
6.11.1.5	External MAC (ID=804)	84
6.11.1.6	External name (ID=805)	84
6.11.1.7	External PIN (ID=806)	84
6.11.1.8	Connection mode (ID=807)	84
6.11.1.9	Authorized devices MAC list (ID=830 - 834)	85
6.12	I/O PARAMETERS	85
6.12.1	<i>I/O#1 property parameter priority Ignition (ID=50000)</i>	85
6.12.2	<i>I/O#1 priority (ID=50001)</i>	85
6.12.3	<i>I/O#1 High level (ID=50002)</i>	85
6.12.4	<i>I/O#1 Low level (ID=50003)</i>	86
6.12.5	<i>I/O#1 Event only (ID=50004)</i>	86
6.12.6	<i>I/O#1 averaging length (ID=50005)</i>	86
6.13	I\O ELEMENTS PARAMETERS AND TYPES.	86
7	MOUNTING RECOMMENDATIONS	91
7.1	CONNECTING WIRES	91
7.2	CONNECTING POWER SOURCE	91
7.3	CONNECTING IGNITION WIRE	92
7.4	CONNECTING GROUND WIRE	92
8	FMB900 INSTALLATION INSTRUCTION	93
9	CHANGE LOG	94

1 INTRODUCTION

1.1 Attention



Do not disassemble the device. If the device is damaged, the power supply cables are not isolated or the isolation is damaged, before unplugging the power supply, do not touch the device.



All wireless data transferring devices produce interference that may affect other devices which are placed nearby.



The device must be connected only by qualified personnel.



The device must be firmly fastened in the predefined location.



The programming must be performed using a second class PC (with autonomic power supply).



The device is susceptible to water and humidity.



Any installation and/or handling during a lightning storm are prohibited.

1.2 Instructions of safety

This chapter contains information on how to operate FMB900 safely. By following these requirements and recommendations, you will avoid dangerous situations. You must read these instructions carefully and follow them strictly before operating the device!

The device uses SELV limited power source. The nominal voltage is 12 V DC. The allowed range of voltage is 10 V...30 V DC.

To avoid mechanical damage, it is advised to transport the FMB900 device in an impact-proof package. Before usage, the device should be placed so that its LED indicators are visible, which show the status of operation the device is in.

When connecting the connection (1x5) cables to the vehicle, the appropriate jumpers of the power supply of the vehicle should be disconnected.

Before dismounting the device from the vehicle, the 1x5 connection must be disconnected.

The device is designed to be mounted in a zone of limited access, which is inaccessible for the operator. All related devices must meet the requirements of standard EN 60950-1.

The device FMB900 is not designed as a navigational device for boats.

1.3 Legal Notice

Copyright © 2016 Teltonika. All rights reserved. Reproduction, transfer, distribution or storage of part or all of the contents in this document in any form without the prior written permission of Teltonika is prohibited.

Other products and company names mentioned here may be trademarks or trade names of their respective owners.

The manufacturer reserves the right to make changes and/or improvements at any time in design, functionality, parameters and electrical characteristics without any prior notice and without incurring obligations.

1.4 About document

This document contains information about the architecture, possibilities, mechanical characteristics, and configuration of the FMB900 device.

Acronyms and terms used in document:

PC – Personal Computer;

GPS – Global Positioning System;

GPRS – General Packet Radio Service;

GNSS – Global Navigation Satellite System ;

GSM – Global System for Mobile Communications;

SMS – Short Message Service;

AC/DC – Alternating Current/Direct Current;

I/O – Input/Output;

Record – AVL data stored in FMB900 memory. AVL data contains GNSS and I/O information;

AVL packet - data packet which is being sent to the server during data transmission.

2 BASIC DESCRIPTION

FMB900 is tracking terminal with GNSS and GSM connectivity, which is able to collect device coordinates and transfer them via GSM network to server. This device is perfectly suitable for applications, which need location acquirement of remote objects.

Package contents¹

The FMB900 device is supplied to the customer in a cardboard box containing all the equipment that is necessary for operation. The package contains:

Already implemented FMB900 device into case;

Top and bottom device cover parts;

Input and output power supply cable with a 1x5 connection pins, which is already installed into device.

¹ Package content depends on Order Code, and can be customized by customer needs.

2.1 Basic characteristics

GSM / GPRS / GNSS features:

- Teltonika TM2500 quad band module (GSM 850 / 900 / 1800 / 1900 MHz);
- GPRS class 12;
- SMS (text, data).
- Integrated GNSS receiver
- Up to -162 dBm GNSS receiver sensitivity.

Hardware features:

- Built-in movement sensor;
- Built-in Bluetooth 3.0;
- Internal High Gain GNSS antenna;
- Internal High Gain GSM antenna;
- microSD card reader (up to 32Gb, FAT32);

Interface features:

- Power supply: 10 ÷ 30V;
- 1 digital input;
- 1 analog input;
- 1 open collector digital output (connecting external relays, LED, buzzers etc.);
- 2 LEDs indicating device status.

Special features:

- Fast position fix;
- High Quality track even in high density urban canyon;
- Ultra small case;
- Ready for harsh environment;
- Color ribbon non-detachable cable;
- Easy to mount in limited access areas;
- Firmly fasten;
- High gain internal GNSS and GSM antennas;
- 2 LED status indication;
- Real-Time tracking;
- Smart data acquisition based on:
 - Time;
 - Angle;
 - Distance;
 - Ignition or any other I/O event;
- Sending acquired data via GPRS;
- GPRS and SMS I/O events;
- Virtual odometer;
- Jamming detection
- Configurable using Secured SMS Commands;
- Overvoltage protection.

Table 1 FMB900 Supply voltage

Description	Voltage	Duration
Normal operation	10-30V	Unlimited
Protection turns on, device turns off	34V	Unlimited
Maximum voltage	<70V	Unlimited
Maximum voltage impulse	90V	5 milliseconds

2.2 Technical features

Part name	Physical specification	Technical details
Navigation LED	LED	Power supply 10...30 V DC 2 W Max Energy consumption ¹ : GPRS: --- 60 mA r.m.s Max., Nominal: --- average 27 mA r.m.s, GPS Sleep: --- average 11 mA, Deep Sleep: --- average 3 mA ² Online Sleep: --- average 16.7 mA, Rated current: --- 250 mA, Operation temperature: -25 °C ... +55 °C Storage temperature: -40 °C ... +70 °C Storage relative humidity 5 ... 95 % (no condensation) Internal fuse: 3A, 125V
Modem LED	LED	
Socket	Soldered inner socket	
USB	Micro USB socket	

Table 1. FMB900 specifications

² ¹Energy consumption has been tested at 12V voltage.

²When in Deep Sleep mode no data storing and sending is activated.

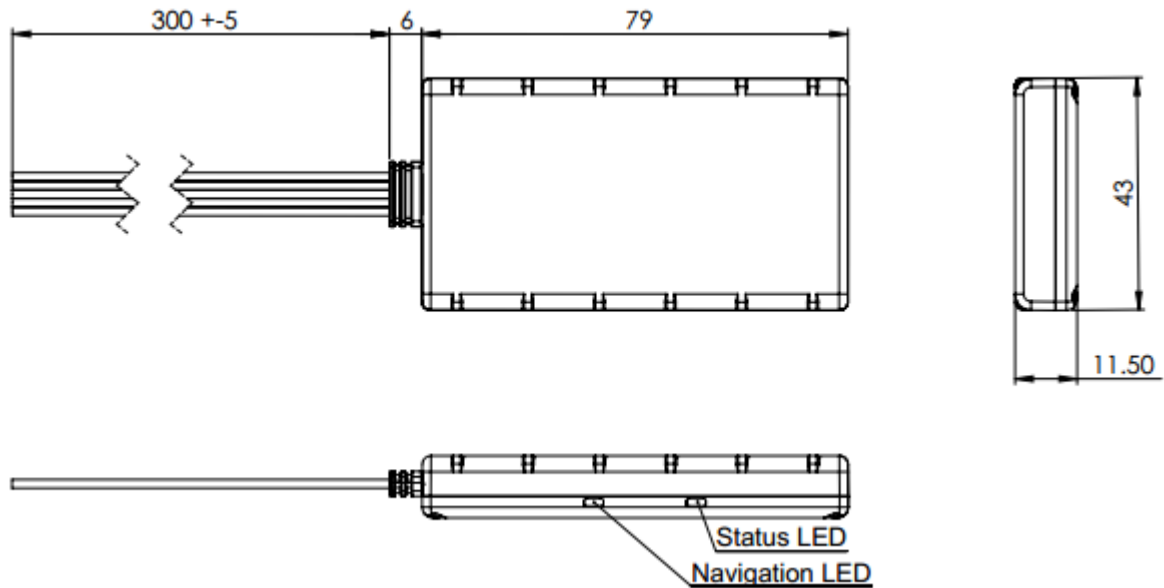

Figure 1 FMB900 view & dimensions (tolerance $\pm 2\text{mm}$)

2.3 Electrical characteristics

CHARACTERISTIC DESCRIPTION	VALUE	Min.	Typ.	Max.	Unit
Supply Voltage:					
Supply Voltage (Recommended Operating Conditions)	10			30	V
Digital Output (Open Drain grade):					
Drain current (Digital Output OFF)				120	μA
Drain current (Digital Output ON, Recommended Operating Conditions)				3,3	mA
Static Drain-Source resistance (Digital Output ON)				300	m Ω
Digital Input:					
Input resistance (DIN1)	47				k Ω
Input Voltage (Recommended Operating Conditions)	0			Supply voltage	V
Input Voltage threshold (DIN1)			2,5		V
Analog Input:					
Input Voltage (Recommended Operating Conditions)	0			30	V
Input resistance			150		k Ω
Measurement error on 12V			0,9		%

Additional error on 12 V		108		mV
Measurement error on 30 V		0,33		%
Additional error on 30 V		88		mV

2.4 Absolute Maximum Ratings

CHARACTERISTIC DESCRIPTION	VALUE	Min.	Typ.	Max.	Unit
Supply Voltage (Absolute Maximum Ratings)		-32		32	V
Drain-Source clamp threshold voltage (Absolute Maximum Ratings), ($I_{\text{drain}} = 2\text{mA}$)				36	V
Digital Input Voltage (Absolute Maximum Ratings)		-32		32	V
Analog Input Voltage (Absolute Maximum Ratings)		-32		32	V



CAUTION: Digital Output (DOUT) is turned ON during every FMB9 device startup for few seconds, i.e. in case of firmware update, restart with SMS command or restart by disconnecting power from device. **DO NOT** connect any sensitive equipment to DOUT, which could harm driver. For example fuel pump disabled during driving, even for few second could be fatal for driver.

3 CONNECTION, PINOUT, ACCESSORIES

3.1 How to insert SIM card into FMB900 device:

① Remove FMB900 cover

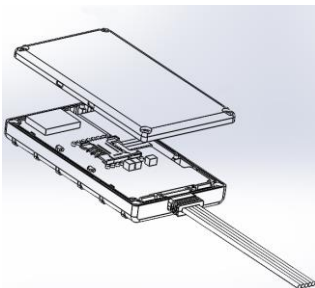

② Insert SIM card as shown

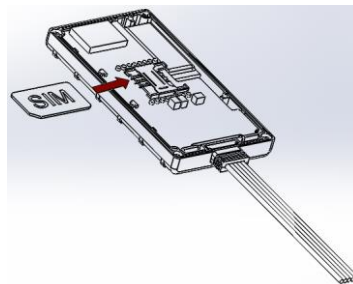

③ Attach cover

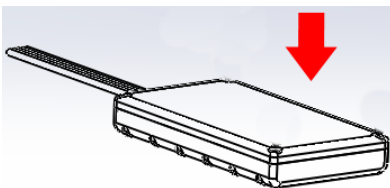

④ Device is ready

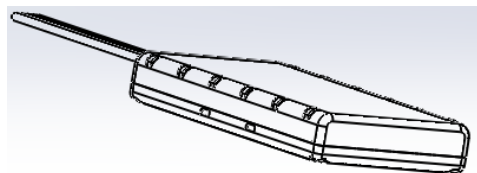

Note: SIM card insertion/removal must be performed when FMB device is powered off – external voltage disconnected. Otherwise SIM card might be damaged or FMB device will not detect it.

3.2 How to add MicroSD card into FMB9XX device

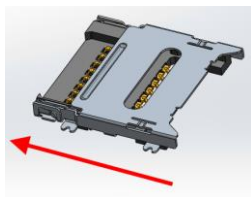

① Push MicroSD card lock case

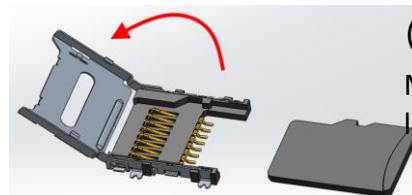

② Open MicroSD card locker

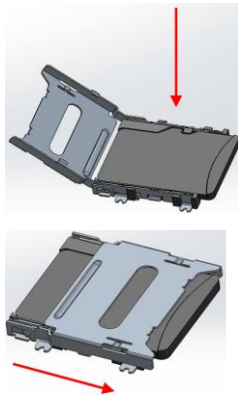

③ Correctly insert microSD card into slot

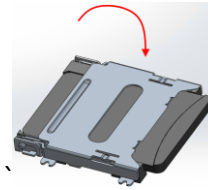

④ Close microSD card locker

⑤ Push microSD card lock case to locked position

3.3 Installing FMB900 drivers

Software requirements:

Operating system (OS)	Version	MS .NET Framework version
Windows XP with SP3 or later	32 bit and 64 bit	MS .NET Framework 4 https://www.microsoft.com/en-US/Download/confirmation.aspx?id=17718 http://avl1.teltonika.lt/downloads/software/Framework/.NET%20Framework%204/dotNetFx40_Full_x86_x64.exe
	32 bit 64 bit	With MS .NET Framework 4 update KB2468871-v2 update https://www.microsoft.com/en-us/download/details.aspx?id=3556 http://avl1.teltonika.lt/downloads/software/Framework/.NET%20Framework%204%20update%20KB2468871-v2/ NDP40-KB2468871-v2-x86.exe NDP40-KB2468871-v2-x64.exe or NDP40-KB2468871-v2-IA64.exe
Windows Vista Windows 7 Windows 8.1 Windows 10	32 bit and 64 bit	MS .NET Framework 4.6.2 https://www.microsoft.com/en-us/download/confirmation.aspx?id=53344 http://avl1.teltonika.lt/downloads/software/Framework/.NET%20Framework%204.6.2/NDP462-KB3151800-x86-x64-AllOS-ENU.exe

Drivers:

Please download COM Port drivers from Teltonika website:
http://avl1.teltonika.lt/downloads/FMB9XY/MS_USB_ComPort_Driver_exe_v1.1032.3.zip

Installing drivers:

Extract and run FP_INBOX_InstallDriver_v1.1032.3.exe. This driver is used to detect FMB900 device connected to the computer. Click 'Next' in driver installation window (figures below):

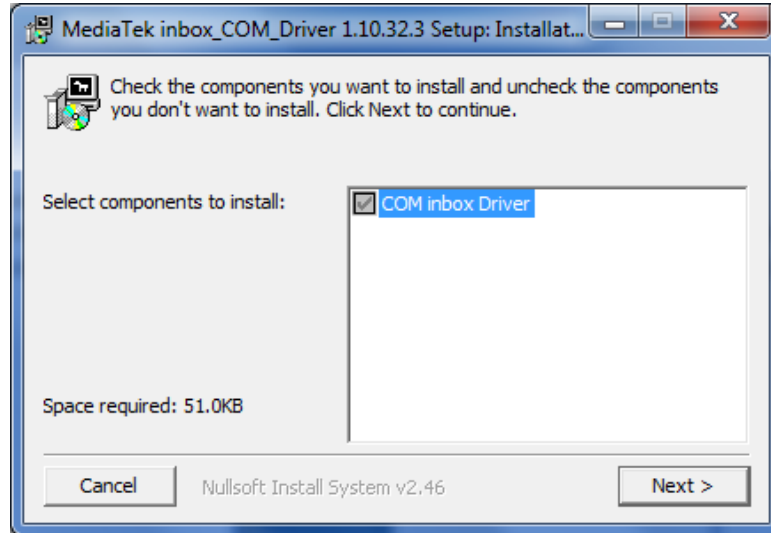

Figure 2 Driver installation window

This will launch device driver installation wizard. In the following window click 'Install' button:

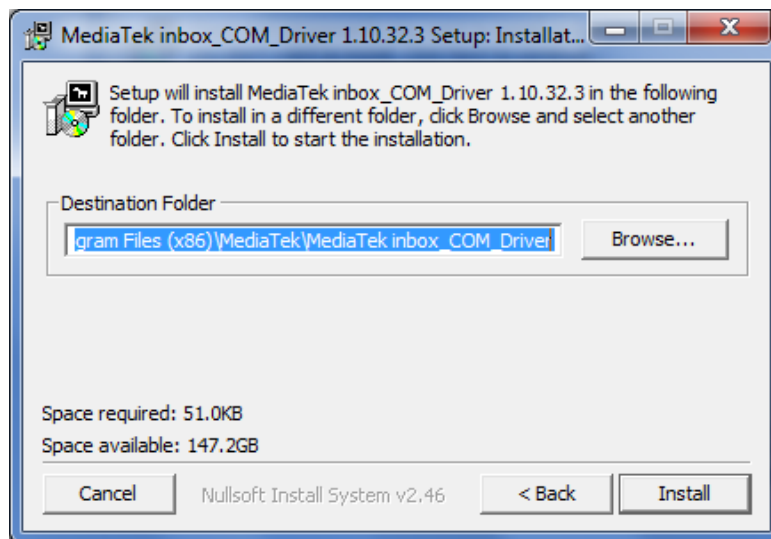

Figure 3 Driver installation window

Setup will continue installing drivers and will display a window about successful process at the end. Click 'Finish' to complete setup:

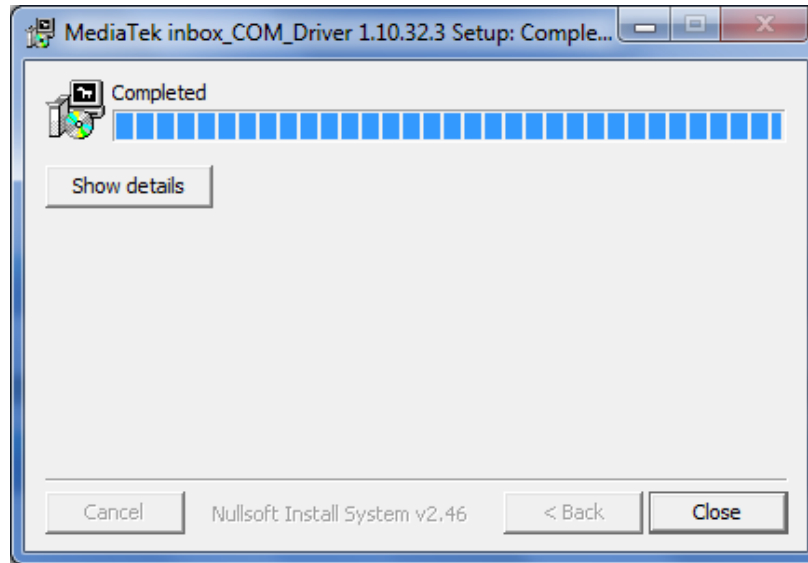

Figure 4 Driver installation window

You have now installed drivers for FMB900 device successfully.

Table 2 FMB900 pinout description

Pin Nr.	Pin Name	Description
1	VCC (10÷30)V DC (+)	Power supply for module. Power supply range (10...30) V DC (+)
2	GND(VCC(10÷30)V DC)(-)	Ground pin. (10÷30)V DC (—)
3	DIN 1	Digital input, channel 1. DEDICATED FOR IGNITION INPUT
4	AIN 1	Analog input, channel 1. Input range: 0-30V DC
5	OUT 1	Digital output, channel 1. Open collector output. Max. --- 3,3 A.

3.4 Accessories



Note: Accessories are not included in device package, please order them separately.

Alarm buttons, door sensors, etc.

Alarm buttons, door sensors, ignition, etc. return two states: high or low voltage. Digital inputs are used to read this information. Figure below shows how to connect alarm button, door sensor, etc.

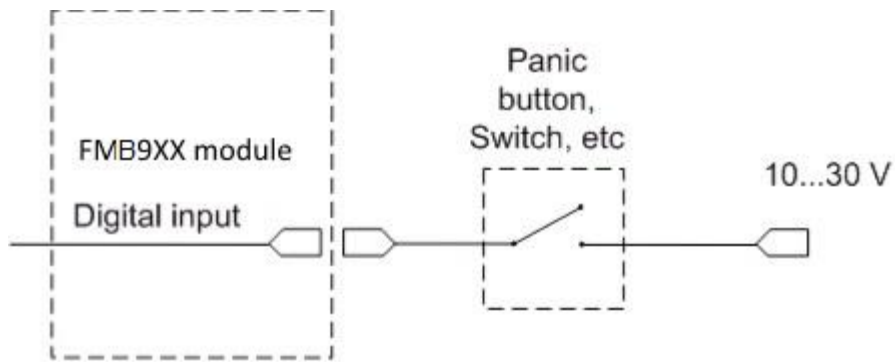

Figure 5 Panic button connection

In cases when sensor output signal is negative, an additional relay has to be installed to convert negative signal to positive.

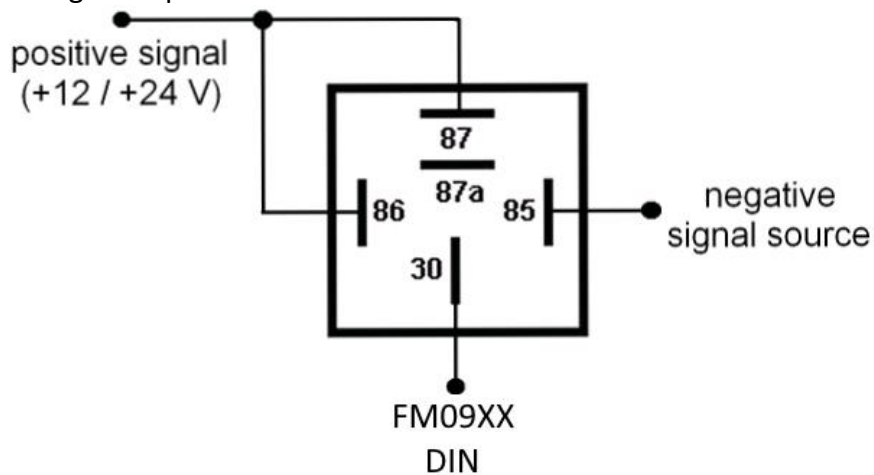

Figure 6 Inverting relay connection

Immobilizer relay

When connected as shown below, FMB900 disables engine starter when output is ON. More details about relays can be found below.

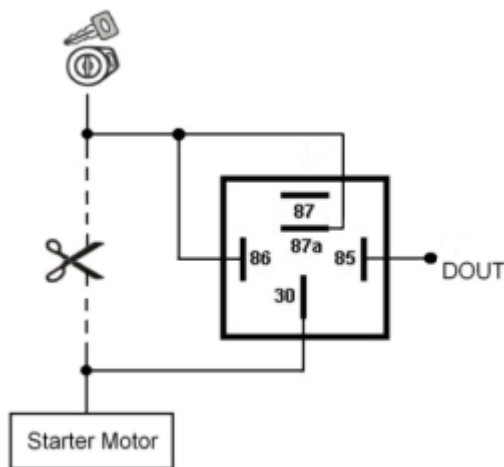

Figure 7 Immobilizer relay connection

Relays

An ordinary automotive relay is used to invert input signal or to immobilize engine starter. Note, that they are available as 12 V or 24 V.

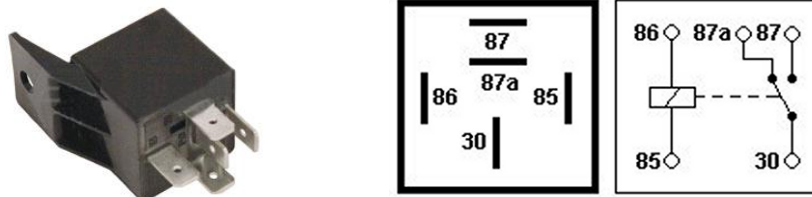

Figure 8 Automotive relay pinout

3.5 Terminal log for FMB devices

FMB device is able to transmit its current state when it is connected to PC using USB cable. It is used to detect errors and provide information for solution when device is operating as unexpected. Required Terminal application can be downloaded here:

<http://avl1.teltonika.lt/Downloads/Software/Terminal.zip>

After connecting FMB device to PC, it creates two ports:

- MTK USB Debug Port – used for modem trace;
- **MTK USB Modem Port** – used for Terminal log.

If connected FMB device is not recognized by PC, please install appropriate drivers. Here is download link:

<http://avl1.teltonika.lt/Downloads/FMB9XY/>

After selecting your port (usually lower number port) click connect and then click on 'Start Log' button. If log is not running, please send .log:1 command (see picture below).

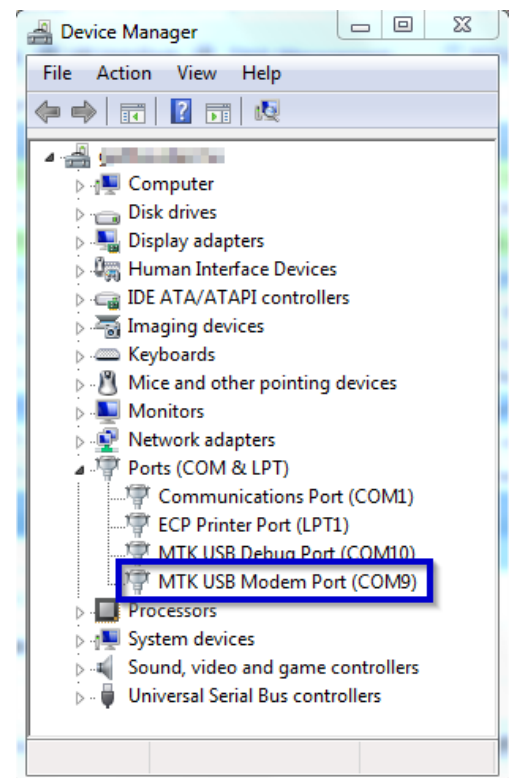

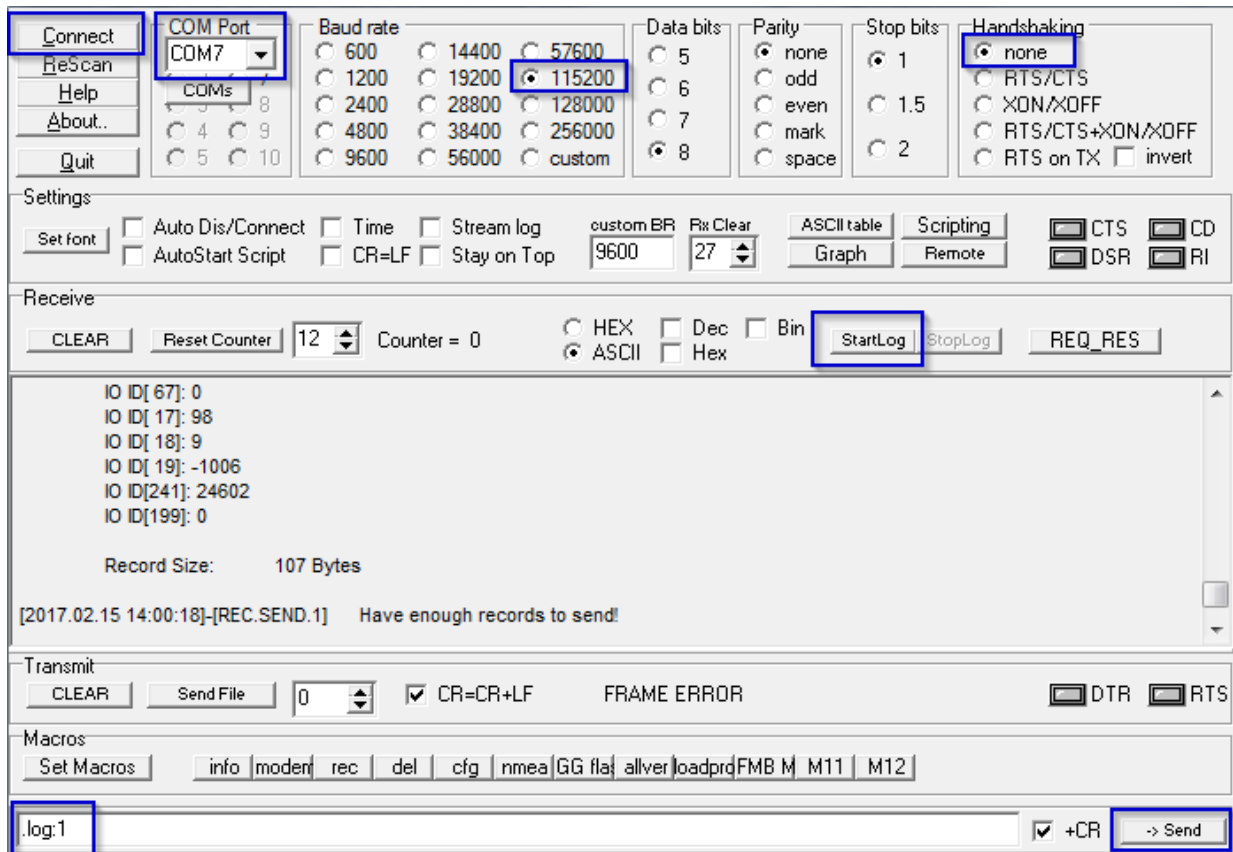

3.6 Navigate LED

Behavior	Meaning
Permanently switched on	GNSS signal is not received
Blinking every second	Normal mode, GNSS is working
Off	GNSS is turned off because: <ul style="list-style-type: none"> • Deep sleep mode Or <ul style="list-style-type: none"> • GNSS antenna short circuited

3.7 Status LED

Behavior	Meaning
Blinking every second	Normal mode
Blinking every 2 seconds	Deep sleep mode
Blinking fast for a short time	Modem activity
Blinking fast constantly	Boot mode
Off	<ul style="list-style-type: none"> • Device is not working Or <ul style="list-style-type: none"> • Device firmware being flashed

4 OPERATIONAL BASICS

4.1 Operational principals

FMB900 module is designed to acquire records and send them to the server. Records contain GNSS data and I/O information. Module uses GNSS receiver to acquire GNSS data and is powered with three data acquiring methods: time-based, distance-based and angle-based. Note, that if FMB900 loses connection to GNSS satellites, it continues to make records, however coordinate in these records remains the same (last known coordinate). All data is stored in flash memory and later can be sent via GPRS.

GPRS and SMS settings are described in later sections. FMB900 communicates with server using special data protocol.

FMB900 can be managed by SMS commands. SMS Command list is described in SMS COMMAND LIST section. Module configuration can be performed only via SMS.

4.2 Sleep modes

4.2.1 Sleep mode

FMB900 is able to go to sleep mode if such mode is enabled.

This timeout (defined period) starts counting when device is in STOP mode. After timeout is reached and all conditions for sleep mode are met, device goes to sleep mode. While in sleep mode, FMB900 turns GPS module off and it is still making new periodic records. As a result power usage decreases, in turn saving vehicle battery.

FMB900 can enter sleep mode if **ALL** of these conditions are met:

- FMB900 has to be configured to work in Sleep mode and start sleep timeout is reached;
- Device must have synchronized time with GNSS satellites;
- No movement by movement sensor is detected;
- Ignition (configured Ignition Source) is off.

FMB900 exits sleep mode when if **ONE** of following conditions are true:

- Movement by movement sensor is detected;
- Ignition (configured Ignition Source) is turned on.

4.2.2 Deep Sleep mode

While in deep sleep mode, FMB900 sets GNSS receiver to sleep mode and turns off GSM/GPRS module (it is not possible to wake up device via SMS). Despite records with last known coordinate are being saved and send to AVL server (GSM/GPRS module is turned on to send data and after that it is turned off again), power usage is decreased to save vehicle's battery. Note, that power saving depends on two configurable parameters: send period and min. record saving period in "X on Stop Mode".

FMB900 can enter deep sleep mode if **ALL** of these conditions are met:

- FMB900 has to be configured to work in Deep Sleep mode;
- Device must be synchronized time with GNSS satellites;
- FMB900 has to be in „X on Stop Mode“ (Configured by Mode switch parameter);

Movement by accelerometer is not detected;
 Ignition (Configured to be detected by Power Voltage, Ignition or Accelerometer) is off;

Min. Record Saving Period (Data Acquisition Mode settings) must be bigger than Active Data Link Timeout parameter, that FMB900 could close GPRS link.

Send period (Data Acquisition Mode settings) minus Active Data Link Timeout must be more than 90 sec., that FMB900 could close GPRS link for at least 90 sec.

Sleep timeout is reached.

FMB900 exits deep sleep mode when if **ONE** of following conditions are true:

Movement by accelerometer is detected;

Ignition (Configured to be detected by Power Voltage, Ignition or Accelerometer) is turned on.

4.3 Virtual odometer

Virtual odometer is used to calculate traveled distance in FMB900 as a separate I/O element. When FMB900 detects movement, it starts counting distance using GNSS signal: every second it checks current location and calculates distance between current and previous point. It keeps adding these intervals until it is time to make a record, then FMB900 records its location and adds odometer value, which is equal to the sum of all distances, measured every second. User can choose Odometer mode: 0 – Normal mode, or 1 – Continuous.

At Normal mode, when record is made, odometer resets to zero and distance calculation starts all over again.

Continuous odometer mode requires ignition (configured Ignition source) to be turned on. Odometer counts all distance calculations from records and sums them to one distance. Continuous odometer stops counting, when vehicle is at stop and ignition is turned off.

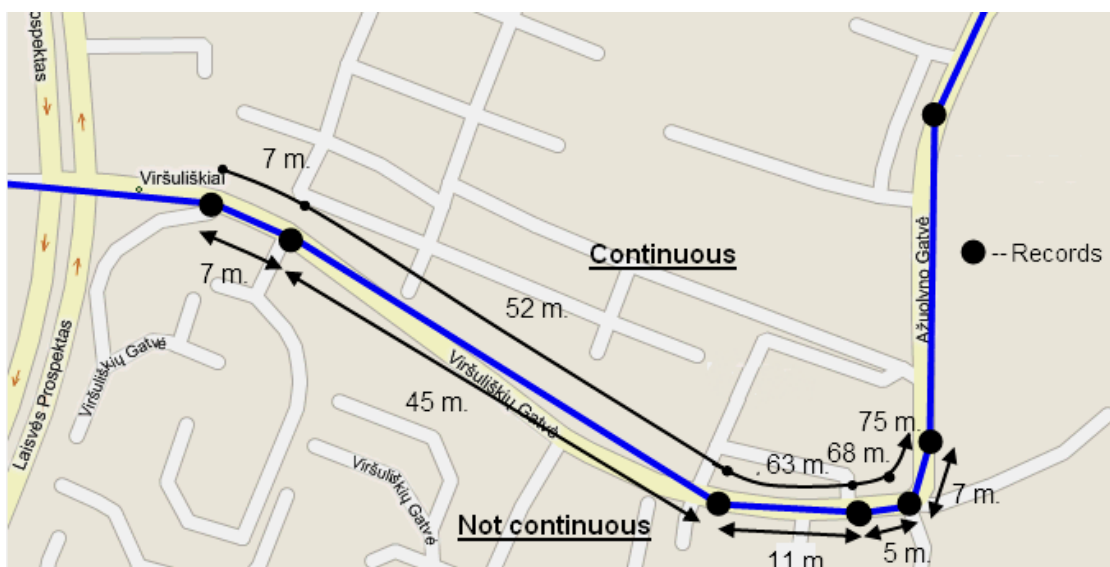

Figure 9 Odometer continuous and Not continuous distance counting parameter example

4.4 Features

Using available features can greatly increase FMB900 usability options.

4.4.1 ECO driving/Green driving Scenarios

Four scenarios are available on FMB900 device.

Digital Output is used by scenarios – ECO driving/Green driving **and/or** Over Speeding;



ECO driving/Green driving Scenarios. Helps to prevent and inspect driver about harsh driving. Eco driving scenario continuously monitors: accelerating, braking and cornering forces depending on build in accelerometer or Green driving depending on GPS. The device inspects driver if needed. Monitoring sensitivity is configurable.

DOUT1 is controlled by scenario for user needs, buzzer or LED for example. Output activation time after harsh event is also configurable.

To save GPRS traffic ECO driving/Green driving event will be **generated (included into records) only** when FMB900 measured values are higher than those set in configuration, without additional I/O settings.

To prevent generating false events, harsh acceleration and harsh braking is monitored only when following conditions are fulfilled:

- Ignition source is ON
- Vehicle speed is equal or higher than 10km/h

Harsh cornering is monitored only when following conditions are fulfilled:

- Ignition source is ON
- Vehicle speed is equal or higher than 30km/h

ECO driving or Green driving Scenario? Eco driving is based on accelerometer value and Green driving based on GPS position.



PLEASE NOTE that Eco Driving functionality generally is dependent on accelerometer. Device must be on plain/horizontal surface to calibrate itself correctly. It calibrates once it is powered up.

4.4.2 Over Speeding Scenario.

Helps to prevent from exceeding fixed speed and inspects driver if needed. DOUT1 is controlled by scenario for user needs, to manage buzzer, LED, etc.

4.4.3 Excessive Idling

Informs you if your vehicle is stationary but engine is on for selected period of time to help you to save fuel

4.4.4 Jamming detection

Jamming detection shows when GSM signal jamming occurs. DOUT1 is controlled by scenario for user needs, to manage buzzer, LED, etc.

4.4.5 Trip

Trip customizable feature enables user extended monitoring of performed trips (from engine start at present location to engine stop at arrived location), log their start and stop points, view driven total distance³. Event will be **generated (included into send records) only** when trip starts and finishes.



Note: Scenarios and Trip feature are activated (DOUTs are activated) only if DIN1=1 (ignition is on).

4.4.6 DOUT Control Via Call

Activates DOUT on incoming call

4.5 GPS Fuel Consumption

This functionality is meant to calculate fuel consumption based on set consumption values in different situations.

4.6 Scenarios Accelerometer

4.6.1 Towing Detection

Towing detection feature helps to inform driver about car departing. FM920 generates event when car is being towed or risen, for example in case of vehicle evacuation.

4.6.2 Crash Detection

If Crash detection is enabled, it monitors acceleration on each axis, which helps to detect an accident

4.7 Bluetooth

Bluetooth can work in two modes - *slave* or *master*.

While working as *master* mode - Bluetooth can connect to defined "*hand free*" or "*OBDII*" system.

While working as *slave* mode - Bluetooth can accept incoming connection from external device.

³ Continuous odometer – total driven distance, works only in TRIP mode. Continues distance is counted only for ONE trip. If trip is finished (stop point is detected), odometer resets to 0 (zero). Next trip will start counting from the beginning.

FMBXX supports one connection at a time.

5 CONFIGURATION

5.1 Configurator

New FMB900 module has default factory settings. Settings should be changed according to your application and your GSM operator information.

FMB900 configuration may be performed via SMS commands or configurator.

FMB900 has one user editable profile.

It can be configured to acquire and send data to server. If device is not able to send data to server, GSM is not available FMB900 will start storing records to flash memory. It is possible to store up to 122880 data records with 64mb SD memory card. It will send data later when GPRS is available again. Note that FMB900 can have memory full of records. In such case it will start deleting oldest records in order to save new ones. Sending all data records to server may take some time.

FMB900 configuration is performed via FMB900 Configurator program. Contact sales manager to get the latest FMB900 Configurator version. FMB900 configurator operates on Microsoft Windows OS and uses MS .NET Framework. For Windows XP you will need MS .NET Framework 4 (with MS .NET Framework 4 update KB2468871-v2) for Windows Vista, Windows 7, Windows 8.1, Windows 10 MS .NET Framework 4.6.2 or later. Please ensure that suitable MS .NET Framework version for your OS is installed on your PC before starting configurator. Latest MS .Net Framework version can be downloaded from official Microsoft web page.

Module configuration is performed over USB cable. Configuration process starts from starting FMB900 Configurator program and then connecting to FMB900 device via Connect button located in Online menu part. FMB900 has one user editable profile, which can be loaded from device, and saved. User can also revert to default settings, by pressing Reset to defaults button. After any modification of configuration settings it has to be saved to FMB900 device, otherwise it will not be written to device.



Note: It is not recommended to downgrade firmware. We can't guarantee that all functions will be working correctly - it is possible that in old firmware versions there won't be some functions.

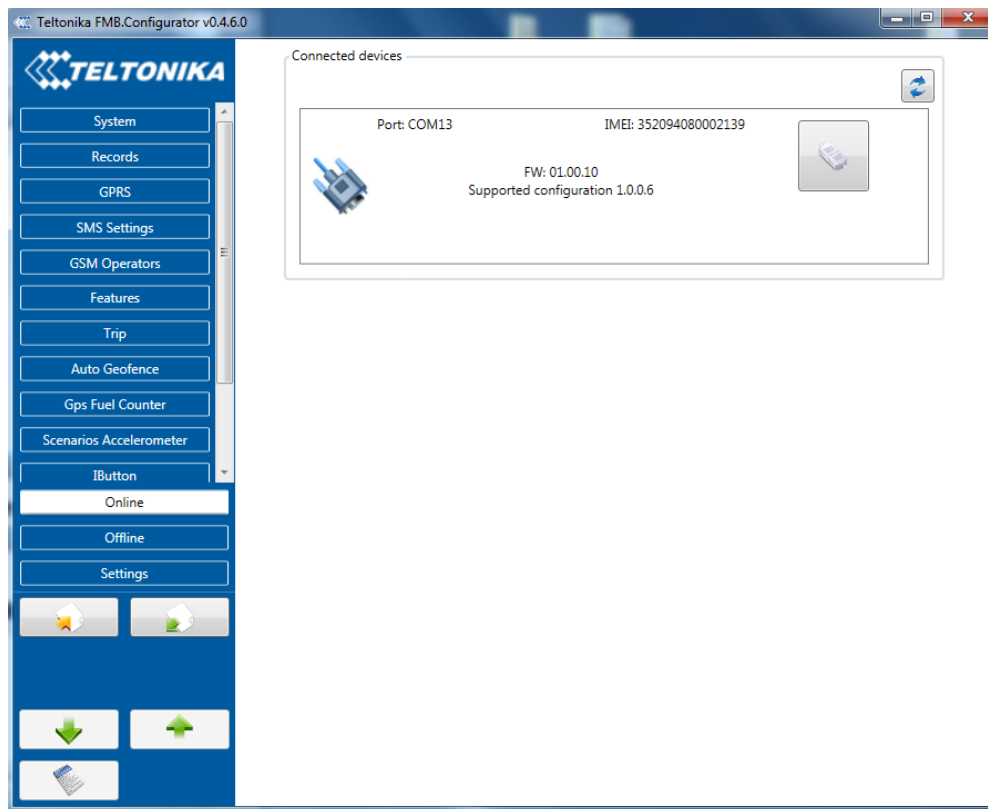

Figure 10 Show home screen of connected device

Main Buttons description:

- 'Scan' – scans for available devices.
- 'Connect to device' – connects device.
- 'Store configuration to file' – saves configuration.
- 'Read configuration from file' – loads saved configuration.
- 'Read configuration' – loads configuration from device.
- 'Store configuration' – saves configuration to device.

Keyword SMS (GPRS) commands:

"setkey <oldkeyword> <newkeyword>" - Set new or change the keyword. Configuration should be not locked. Example:

New keyword (set):

<name>{space}<pass>{space}setkey{space}{space}{space}<newkeyword>

Change keyword (change):

<name>{space}<pass>{space}setkey{space}<oldkeyword>{space}<newkeyword>

"delkey <keyword>" - Deletes current keyword. Configuration keyword should be configured and not locked.

Example:

<name>{space}<pass>{space}setkey{space}<keyword>

Keyword configuration with TCP

Param ID 10 used for keyword configuration. Configuration should not be locked. Send empty if want delete the keyword, or not empty if want change/set

Param ID 10 config reading from SMS/GPRS forbidden.

5.2 System settings

System settings 9 configurable parameters:

- Sleep settings, where user can choose sleep mode;
- Ignition source, where user can choose between power voltage, digital input 1 and accelerometer ignition sources
- Object Motion Detection Settings, where user can configure 3 ways how FMB900 will detect stopped movement, and change its working mode (for working modes, read section 5.7);
- Static navigation settings, where user can turn static navigation on or off;
- Records Settings, where user can enable or disable records when GPS is not available (no time synchronization);
- GNSS source Settings, where user can choose satellite system.
- LED indication, where user can turn on or off indication leds.

Table 3 Configuration parameters

Movement Source	Vehicle on Stop mode	Vehicle Moving mode
Ignition (recommended)	If ignition (DIN1) is logic low	If ignition (DIN1) is logic high
Movement (movement sensor)	Internal movement sensor does not detect movement	Internal movement sensor detects movement
GPS	GPS fix is available and vehicle speed is lower than 5 km/h	GPS fix is available and vehicle speed is higher than 5 km/h
	While GPS fix is unavailable, Object Motion Detection Settings are working like in Msensor mode	

Static Navigation Mode is a filter, which filters out track jumps when the object is stationary. If Static navigation filter is disabled, it will apply no changes on GPS data. If Static navigation filter is enabled, it will filter changes in GPS position if no movement is detected (depends on Object Motion Detection Settings). It allows filtering GPS jumps when object is parked (is not moving) and GPS position is still traced.

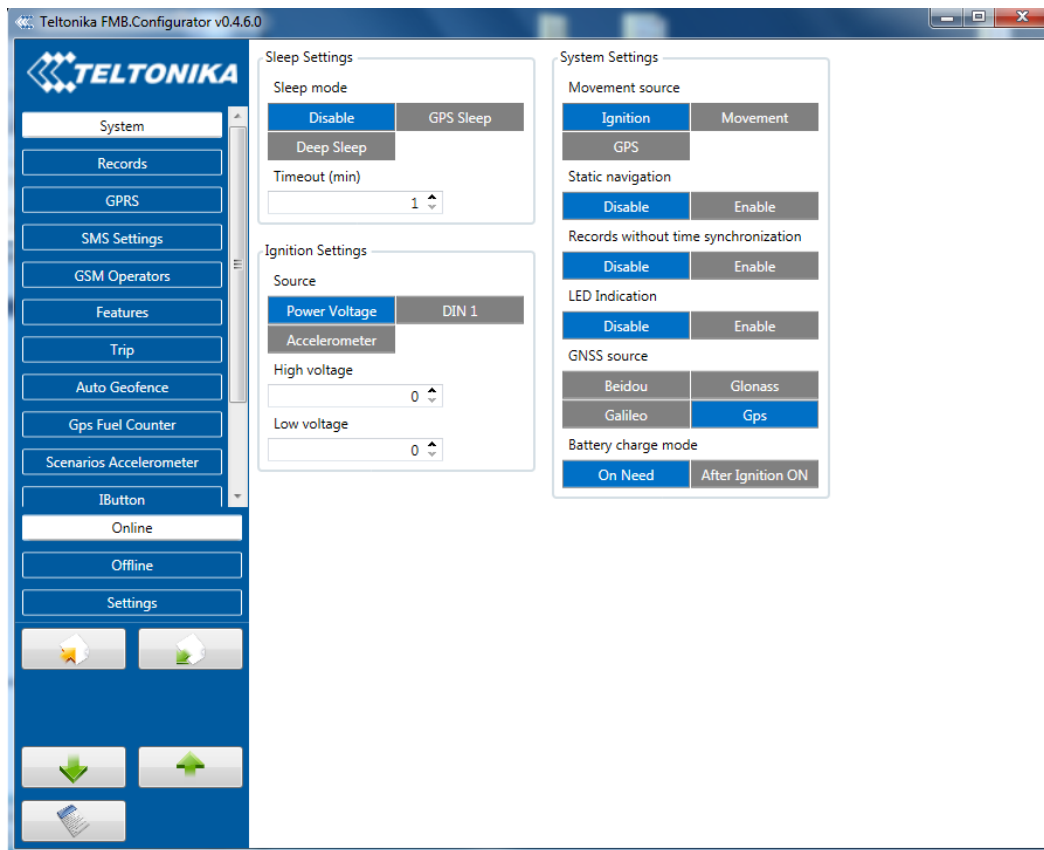

Figure 11 System settings configuration

In GNSS source Settings user can configure which GNSS system or systems to use.

User has choice to use only one system of GPS, Glonass, Galileo or Beidou. Also it is able to chose two or three systems together. One exception is that you can not combine Beidou and Glonass systems together.

List of configurable GNSS sources:

Beidou only	ID:01
Glonass only	ID:02
Galileo only	ID:04
Galileo+Beidou	ID:05
Galileo+Glonass	ID:06
GPS only	ID:08
GPS+Beidou	ID:09
GPS+Glonass	ID:10
GPS+Galileo	ID:12
GPS+Galileo+Beidou	ID:13
GPS+Galileo+Glonass	ID:14

List of **NON**-configurable GNSS sources:

- Glonass+Beidou
- Galileo+Glonass+Beidou
- GPS+Glonass+Beidou
- GPS+Galileo+Glonass+Beidou

GNSS source

Beidou	Glonass
Galileo	Gps

Example of good configuration

GNSS source

Beidou	Glonass
Galileo	Gps

Example of bad configuration

5.3 Records settings

Here user can modify if FMB900 device will send newest records first, meaning, that the most important thing is to know recent position of car, older records are being sent right after newest records arrive to AVL application.

Activate Data Link Timeout is used to set timeout of link between FMB900 and AVL application termination. If FMB900 has already sent all records it waits for new records before closing link. If new records are generated in the period of this timeout, and minimum count to send is reached, they are sent to AVL application. This option is useful when GSM operator charge for link activation.

Server Response Timeout is used to set time period waiting for response from server side.

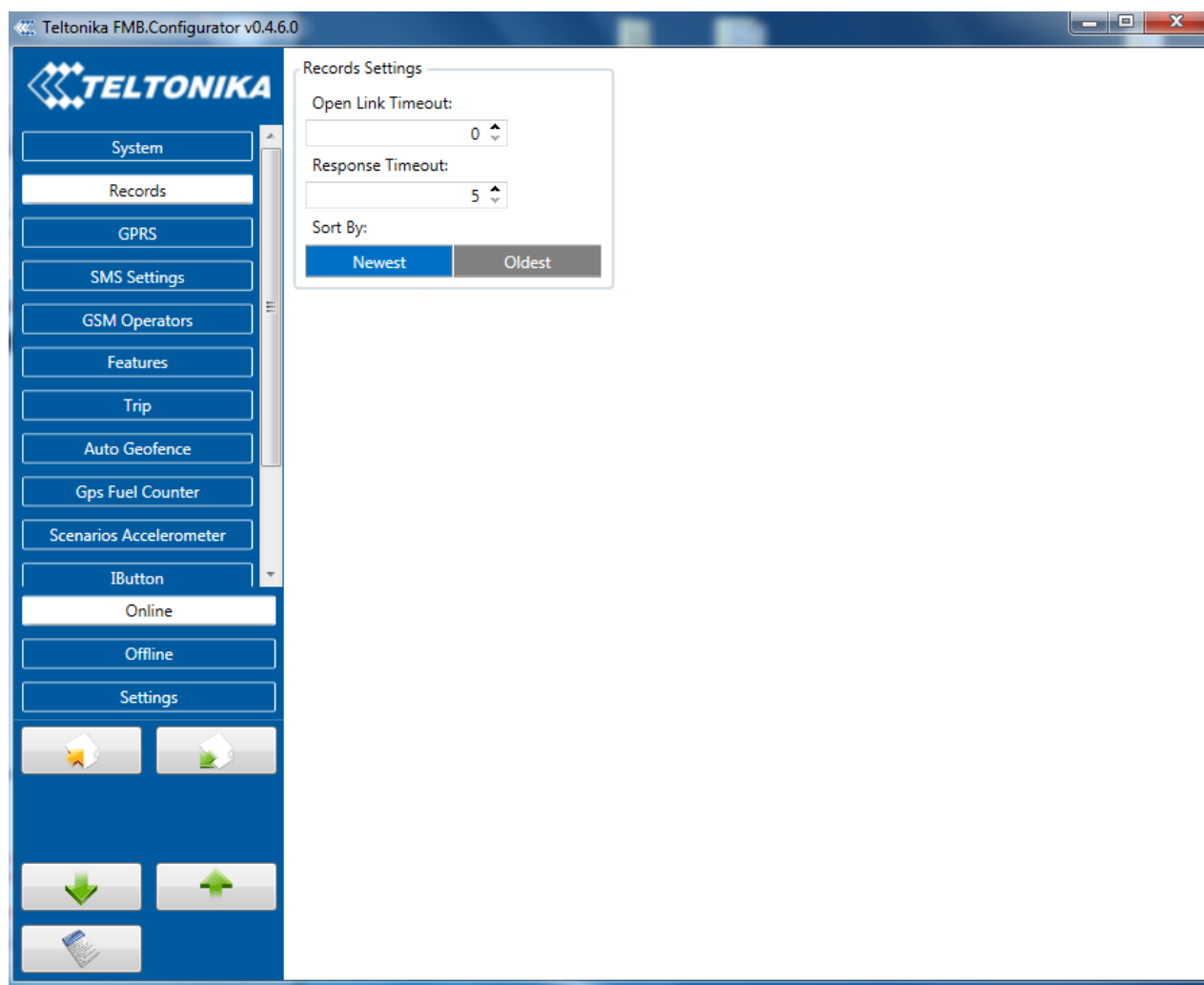

Figure 12 Records settings configuration

5.4 GSM settings, GPRS part

'GPRS' defines main parameters for FMB900: GSM operator APN and GPRS username and password (optional – depending on operator), destination server IP and port, and allows to set protocol used for data transfers – TCP or UDP.

Some operators use specific authentication for GPRS session – CHAP or PAP. If any of these is used, APN should be entered as 'chap:<APN>' or 'pap:<APN>'. I.e. if operator is using APN

'internet' with CHAP authentication, it should be entered as 'chap:internet'. Information about APN and authentication type should be provided by your GSM operator.

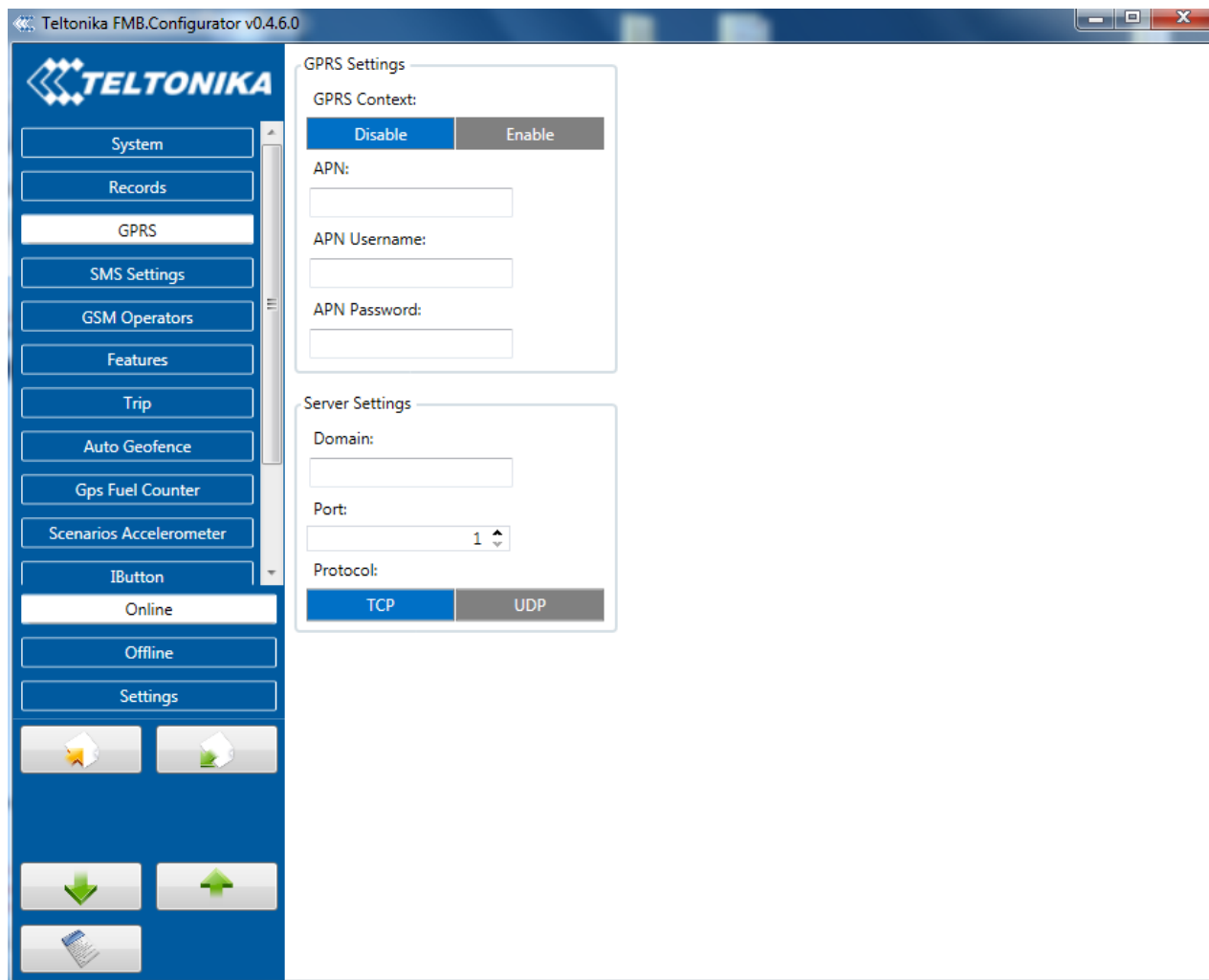

Figure 13 GPRS configuration

5.5 GSM settings, SMS/Call part

Essential fields in 'SMS' part are 'Login' and 'Password'. The login and password are used with every SMS sent to FMB900. If login and password are not set, in every SMS sent to FMB900 device two spaces before command have to be used (<space><space><command>).

Command structure with set login and password:

<login><space><password><space><command>, example: "asd 123 getgps"

Phone numbers have to be written in international standard, without using "+" or "00" signs in prefix. If no numbers are entered, configuration and sending commands over SMS are allowed from all GSM numbers.

SMS data sending settings – enable or disable **periodic** data and event SMS usage. This setting does not affect replies to SMS request messages – answers are always sent back to sender telephone number.

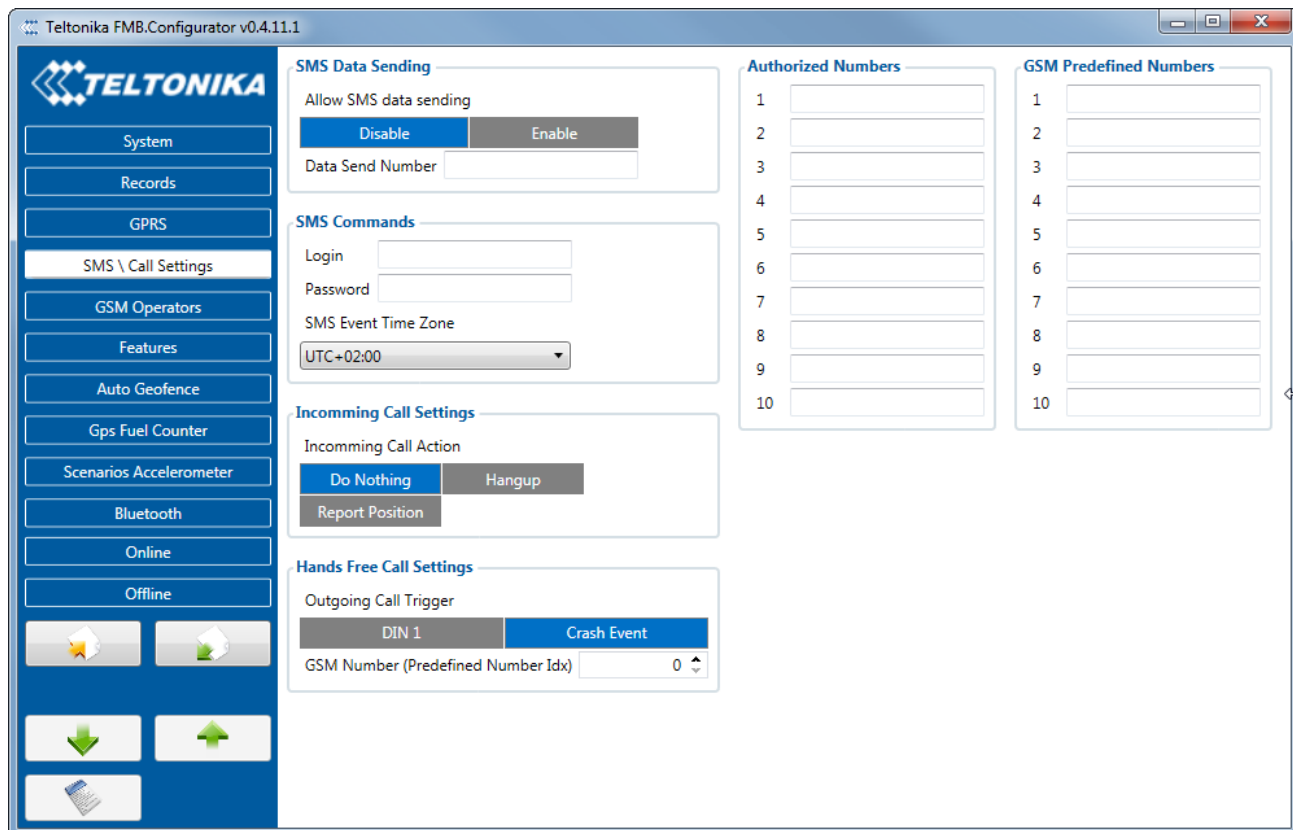
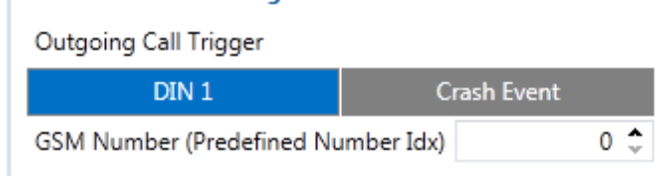

Figure 14 SMS configuration

Hands free call functionality

When FMBXX is connected to hands free headset it can call to user defined GSM numbers.

Hands Free Call Settings



Outgoing Call Trigger parameter determines which event will triggers call. FMBXX supports four different call triggers:

- None selected – disables call trigger functionality.
- DIN1 – first digital input event triggers call to user selected GSM number.
- Crash Event – crash event triggers call to user selected GSM number.
- DIN1 and Crash Event – both events triggers call to user selected GSM number.

SMS Event Time Zones

FMB9XX works with synchronized GPS time which is UTC+0, with this option customer can configure his time zone and get SMS with correct time.



Note: Please do not set Data Send Number to some cell phone number, because it will not understand binary SMS. When sending a binary SMS to a phone number, which is a server phone number, the server can interpret and understand binary code, so the data can be read and you can view it on the server.



SMS login and password and authorized number list are used to protect FMB900 module from unauthorized access. Module accepts messages only from a list of authorized numbers and with proper module login and password. Numbers must be without “+” or “00” prefix. If no authorized numbers are entered, module accepts messages from all numbers.

5.6 GSM settings, Operator list

Operators list – FMB900 can work in different modes (use different settings) according to the operator list defined. Operator list is used for Data Acquisition Mode switching (see chapter 5.7 Data Acquisition Mode settings for more details). Modes are changed based on GSM operator FMB900 is connected to.

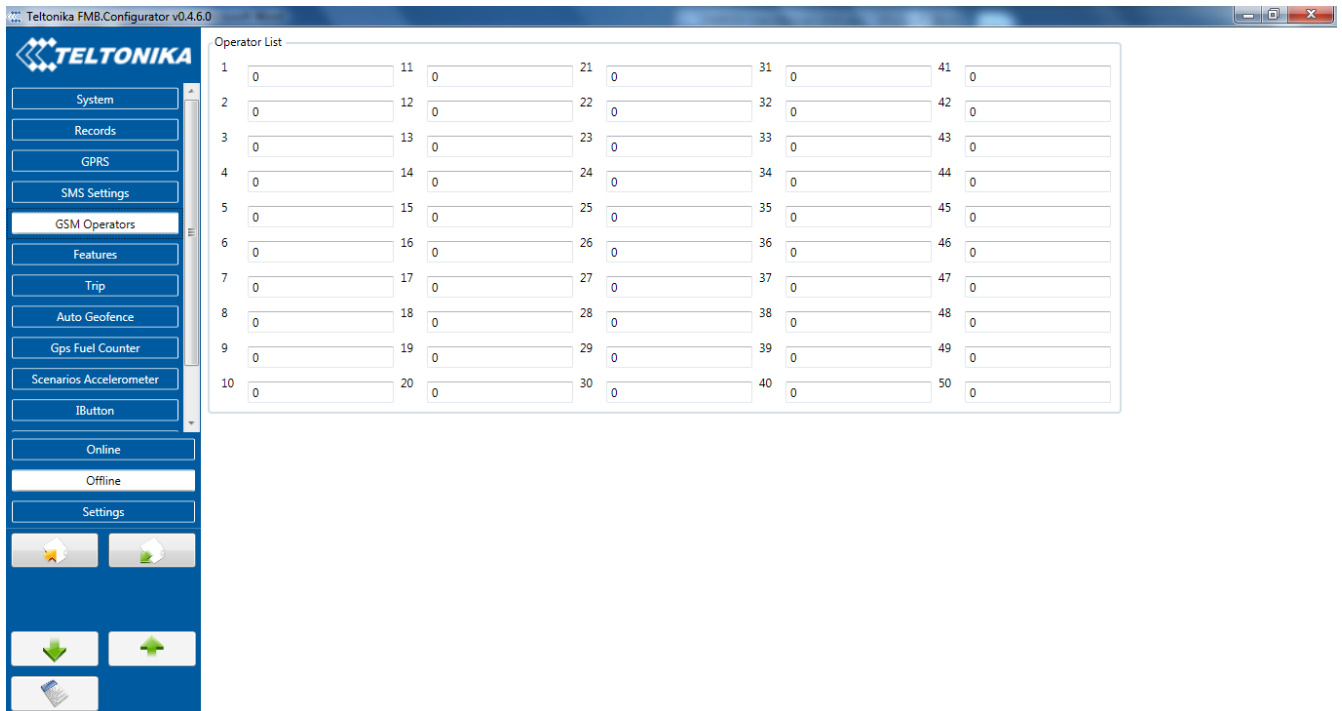

Figure 15 Operator list configuration

If operator list is left empty, it will allow using GPRS to any GSM operator. Please note that FMB900 will work in **Unknown mode only** (make sure it is configured to allow data sending – GPRS context is enabled).

5.7 Data Acquisition Mode settings

Data Acquisition Modes are an essential part of FMB900 device, it is also highly configurable.

By configuration user defines how records will be saved and sent. There are three different modes: Home, Roaming and Unknown. All these modes with configured data acquisition and send frequencies depend on current GSM Operator defined in Operator list (see section 5.6) and are switched when GSM operator changes (e.g. vehicle passes through country boarder).

If current GSM operator is defined as Home Operator, device will work in Home Data Acquisition mode, if current operator is defined as Roaming Operator, device will work in Roaming Data Acquisition mode, and if current operator code is not written in Operator list (but there is at least one operator code in the operator list), device will work in Unknown Acquisition mode.

This functionality allows having different AVL records acquire and send parameters values when object is moving or stands still. Vehicle moving or stop state is defined by Stop Detection Source parameter. There are 3 ways for FMB900 to switch between Vehicle on Stop and Vehicle Moving modes see section 5.7.

FMB900 has 6 different modes. Operational logic is shown in Figure 24.



If there are no operator codes entered into operator list, FMB900 will work in Unknown network mode ONLY.

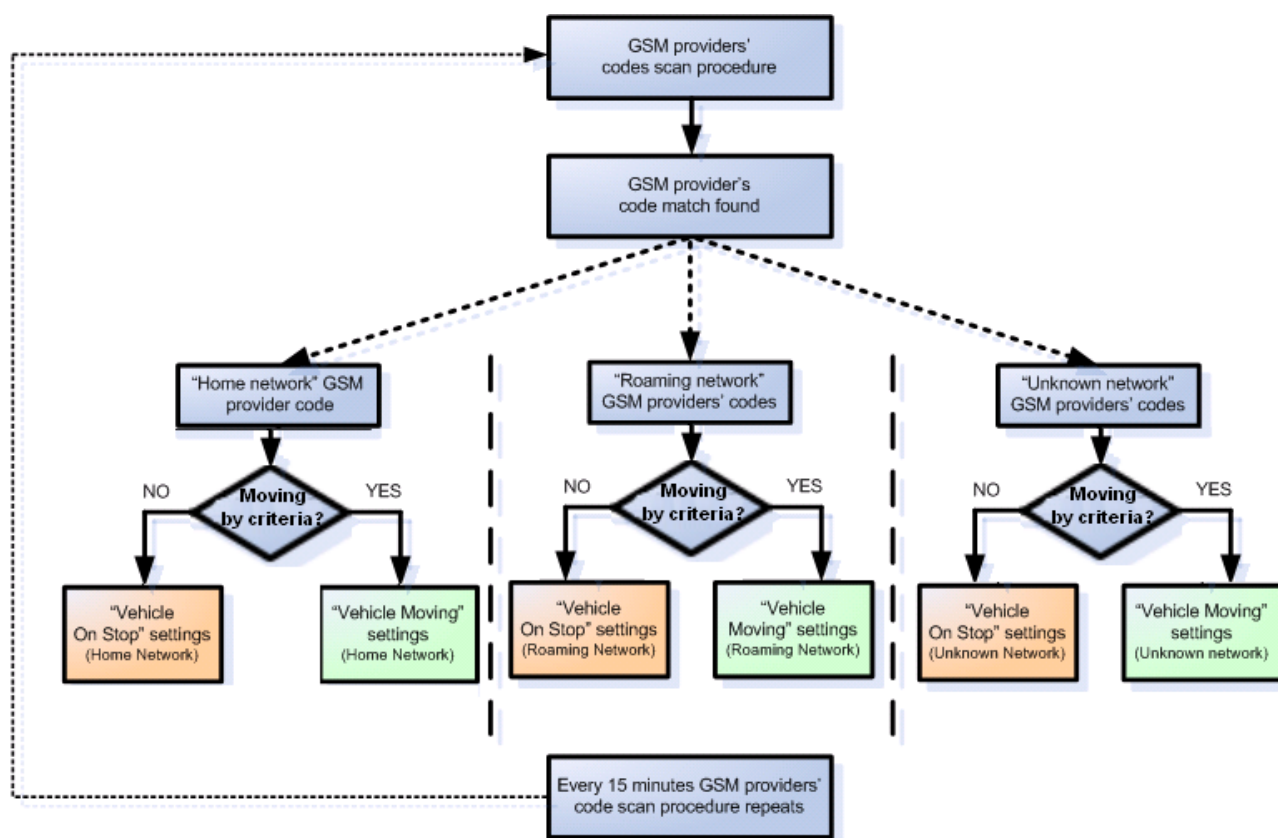

Figure 16 Data Acquisition Mode configuration

Operator search is performed every 15 minutes. Depending on current GSM operator, Home, Roaming or Unknown mode can be changed faster than every 15 minutes. This process is separate from operator search. Movement criteria are checked every second.

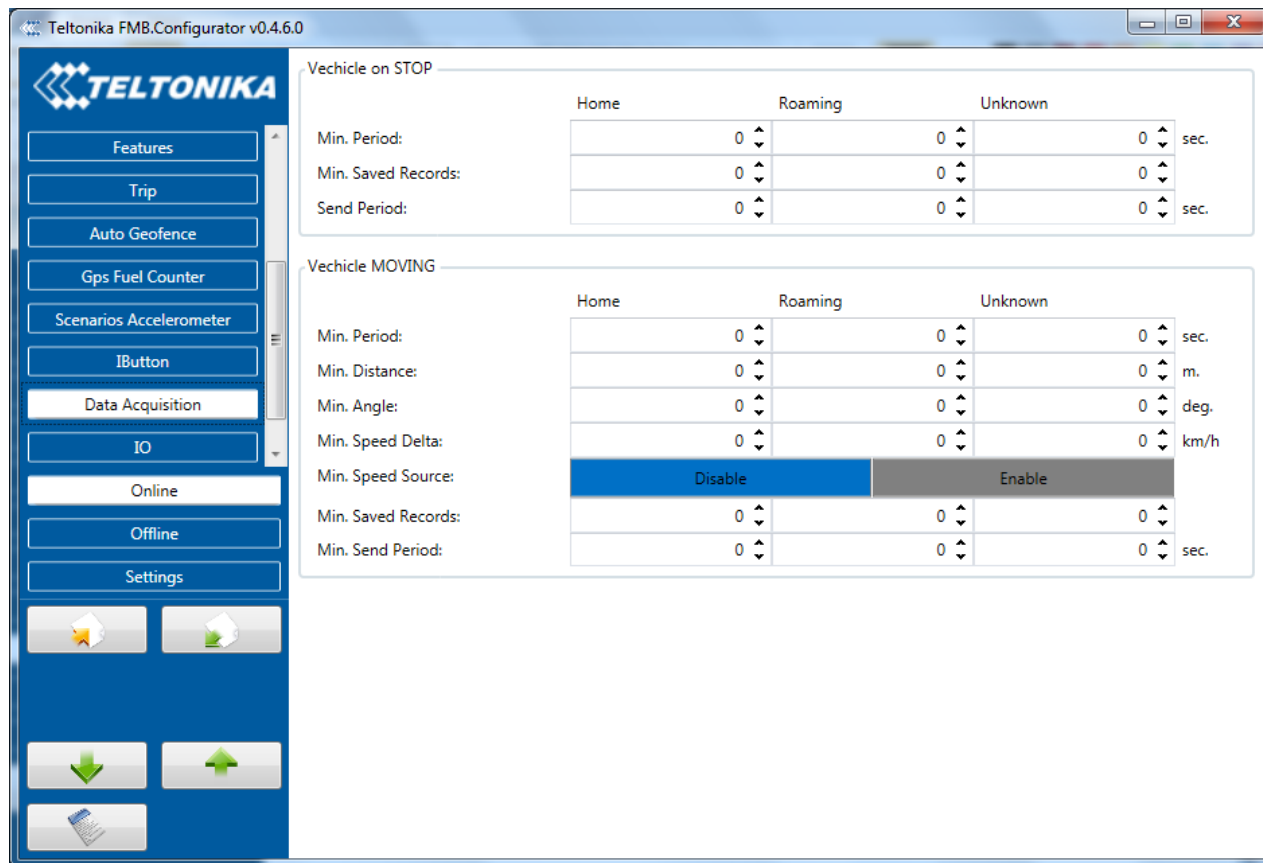

Figure 17 Data Acquisition Mode configuration

'Min Saved Records' defines minimum number of coordinates and I/O data that should be transferred with one connection to server. If FMB900 does not have enough coordinates to send to server, it will check again after time interval defined in 'Sending Period'.

Send period – GPRS data sending to server period. Module makes attempts to send collected data to server every defined period. If it does not have enough records (depends on parameter Min. Saved Records described above), it tries again after defined time interval.



Note: Keep in mind that FMB900 operates in **GMT:0** time zone, without daylight saving.

FMB900 is able to collect records using four methods at the same time: time, distance, angle and speed based data acquisition:

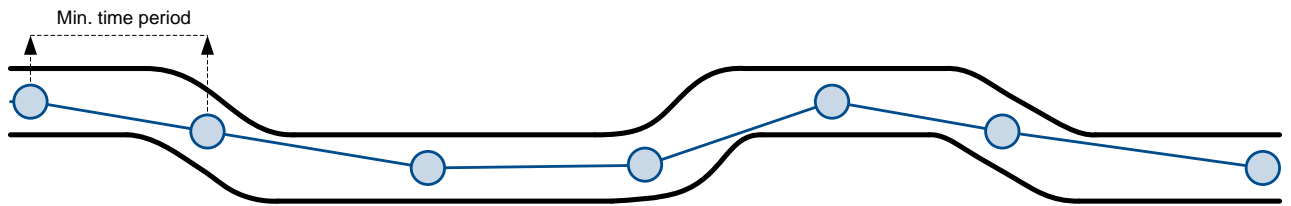

Distance based data acquiring (Min. distance) – records are being acquired when the distance between previous coordinate and current position is greater than defined parameter value. Entering zero disables data acquisition depending on distance.

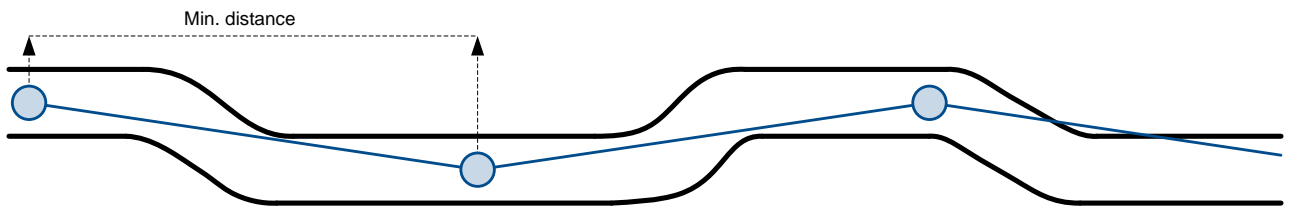

Angle based data acquiring (Min. angle) – records are being acquired when angle difference between last recorded coordinate and current position is greater than defined value. Entering zero disables data acquisition depending on angle.

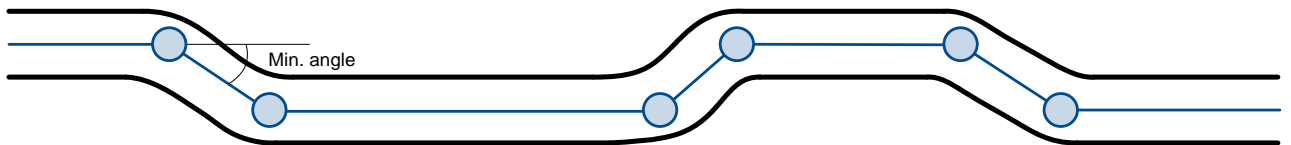

Speed based data acquiring (Min. Speed Delta) – records are being acquired when speed difference between last recorded coordinate and current position is greater than defined value. Entering zero disables data acquisition depending on speed.

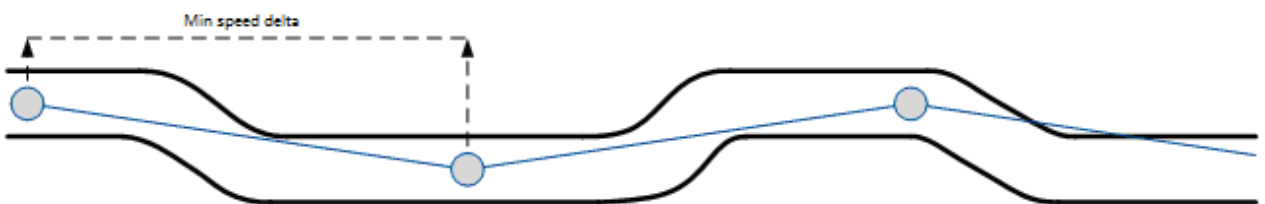

5.8 Features settings

In Features window five different scenarios are available.

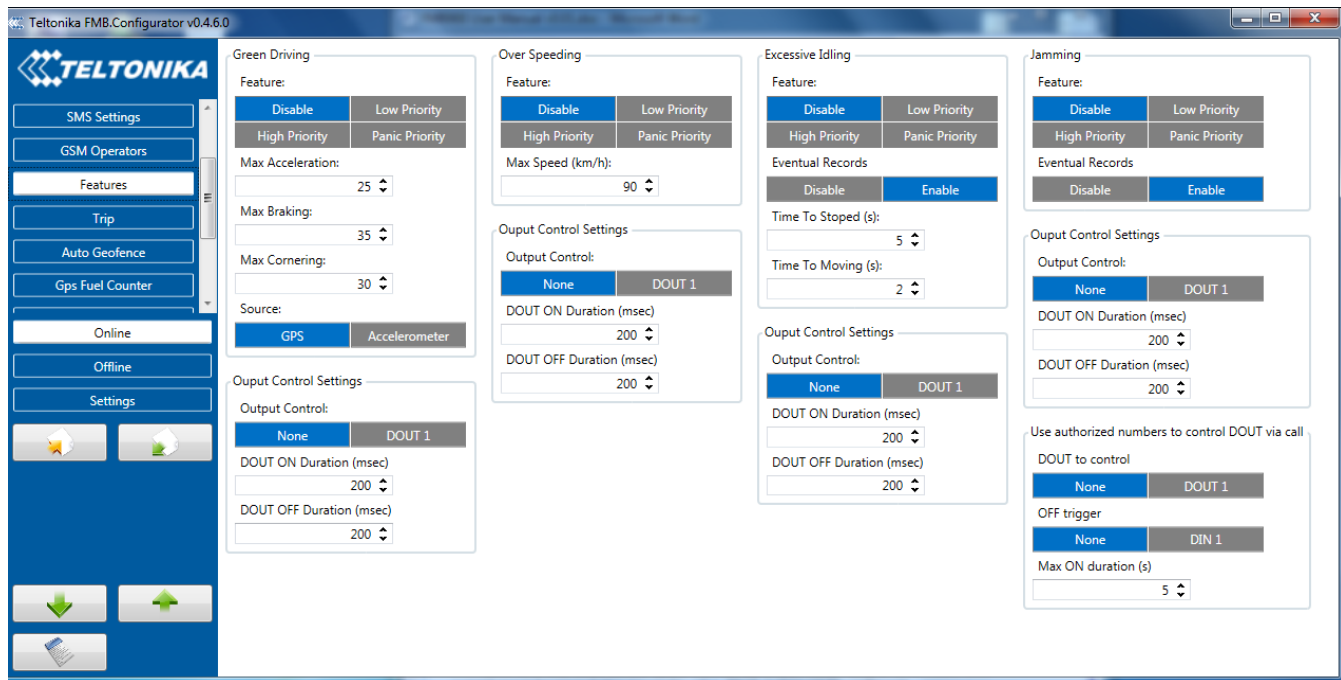

Figure 18 Scenarios configuration

5.8.1 Eco/Green Driving

Scenario is activated and DOUT1 is ON, when vehicle exceeds on of Max. Acceleration, Max Braking or Max Cornering parameters value. You can configure Max. Acceleration and Max. Braking parameters in mG (miliG) units and Max. Cornering parameter in rad/s units. Scenario is activated until current Acceleration, Braking or Cornering value decreases below parameter value.

Parameters used with ECO driving/Green driving functionality.

Green Driving

Scenario settings

Disable	Low Priority
High Priority	Panic Priority

Max Acceleration (mG)

Max Braking (mG)

Max Cornering (mG)

Source

GPS	Accelerometer
-----	---------------

ECO driving/Green driving configuration parameters

Table 27 ECO driving/Green driving parameters description

ECO driving/Green driving configuration parameter name	Description
ECO driving/Green driving	Enable/Disable ECO driving/Green driving functionality
Max Acceleration Force	Value which can be reached while accelerating without triggering harsh acceleration event.
Max Braking Force	Value which can be reached while braking without triggering harsh braking event.
Max Cornering Force	Value which can be reached while cornering without triggering harsh cornering event.

5.8.1.1 Data output

ECO driving/Green driving functionality generates events on three cases. If vehicles:

- Acceleration exceeds defined parameter value
- Deceleration (braking) exceeds defined value
- Cornering force exceeds defined value

Program continuously monitors and process data from accelerometer than decides whether harsh event is detected or not. If any of three cases are satisfied event is generated. Record is saved and sent to server (FMB900 must be configured properly). Event value is multiplied by 10 before sending/saving record to get more precision when displaying **data***.

Digital output No.1 is activated for a period of time to warn driver. Output on-time should/can be configured separately for each case.

***Example.** If acceleration harsh event of 3.55 m/s² detected. Record with value $3.55 \times 10 = 35.5 \approx 36$ will be saved and sent to server.

5.8.1.2 Auto Calibration

1. Vehicle stopped
2. Road is straight
3. Send SMS "auto_calibrate"
4. Accelerate to > 30 km/h for 5 sec.
5. FMB will send response when calibration is success.

Calibration is saved to Internal Flash, after restart should be the same

To check autocalibration status send: position_info

To zero out accelerometer axis SMS: "calibrate", can be used, vehicle speed must be 0 km/h.

5.8.2 Over Speeding

Scenario is activated and DOUT1 is ON, when vehicle speed exceeds parameter value. Scenario is activated until current speed decreases below parameter value.

5.8.3 Excessive Idling

Scenario is activated and DOUT1 is ON, when vehicle stops for specific amount of time. You can configure time it takes to turn on this scenario (Time to Stopped). Scenario is activated until vehicle starts moving and keeps moving for amount of time that is configured. You can configure time it takes to turn OFF this scenario (Time to Stopped).

5.8.4 Jamming

Scenario is activated and DOUT1 IS ON, then jamming is detected.

5.8.5 DOUT control via call

Scenario is activated and DOUT1 IS ON, when call is received from number who is in authorized numbers list.

Call control

- When FMBXX is configured to control *DOUT1* device waits incoming call from configured secure number. If call is received FMBXX turns on *DOUT1* for user defined *Duration timeout (s)*.
- *DOUT1* can be turned off before *Duration timeout (s)* by *DIN1 (DOUT deactivation settings)*.

In all scenarios Digital Output can be controlled independent from scenario.

DOUT ON Duration parameter shows for how long DOUT is set on after scenario is activated. DOUT OFF Duration parameter shows how much time should pass after DOUT is set off till next event can be generated. These parameters must be configured in ms.

5.8.6 Trip settings

Trip window offers user to configure Trip feature. If Trip is enabled configuration of parameters are enabled.

Start Speed – GPS speed has to be greater than the specified Start Speed in order to detect Trip Start.

Ignition Off Timeout – timeout to wait if ignition was off, to detect Trip stop.

Continuous distance counting – Not or Continuous can be chosen. For this feature I/O Odometer must be enabled.

If I/O Odometer is enabled and Continuous distance counting variable (Mode) is set to Continuous, **Trip distance** is going to be counted continuously (**from Trip start to Trip stop**). This value is written to I/O Odometer value field. When Trip is over and next Trip begins, Odometer value is reset to zero. When the next trip starts counting continuously starts from the beginning again.

If I/O Odometer is enabled and Continuous Distance Counting variable (Mode) is set "Between Records", then the distance is going to be counted only between every record made. This value is written to I/O Odometer value field and reset to zero every new record until Trip

stops. If later all Odometer values are summed up manually, the user gets the distance driven during the whole period of the Trip.

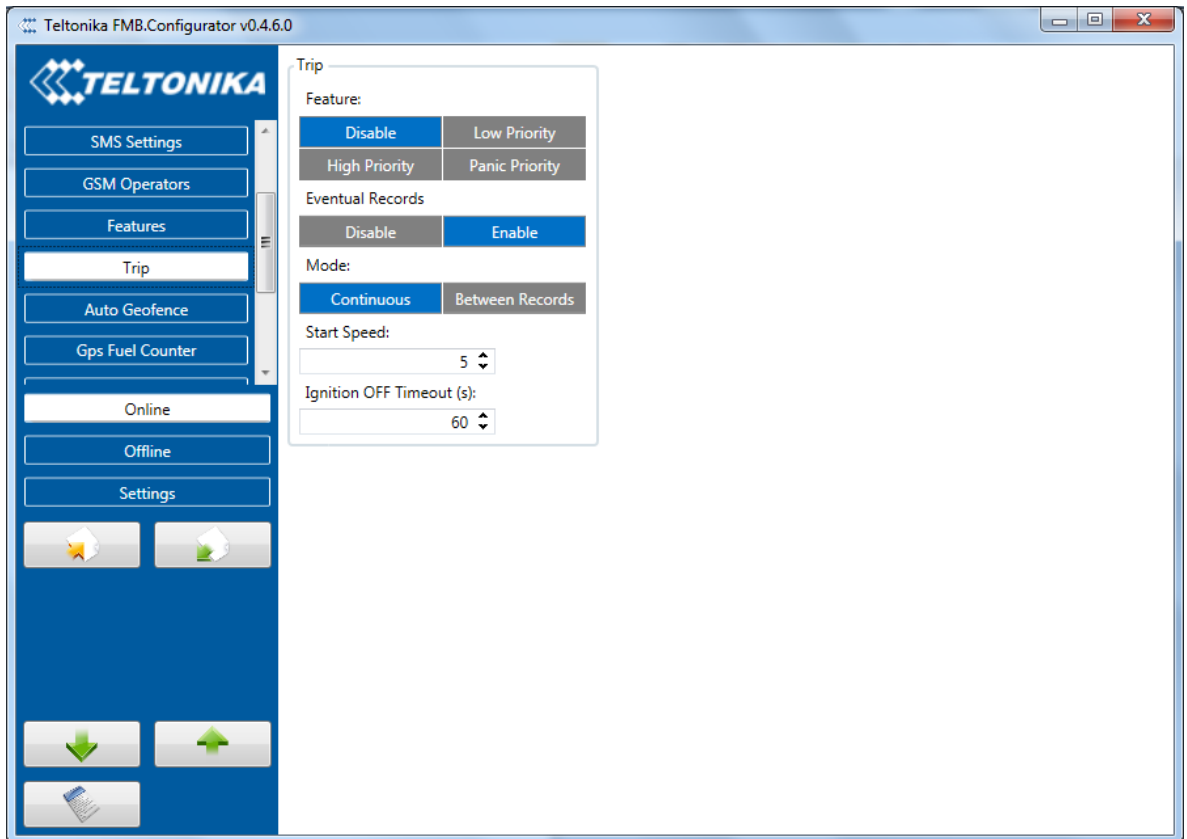

Figure 19 Trip configuration

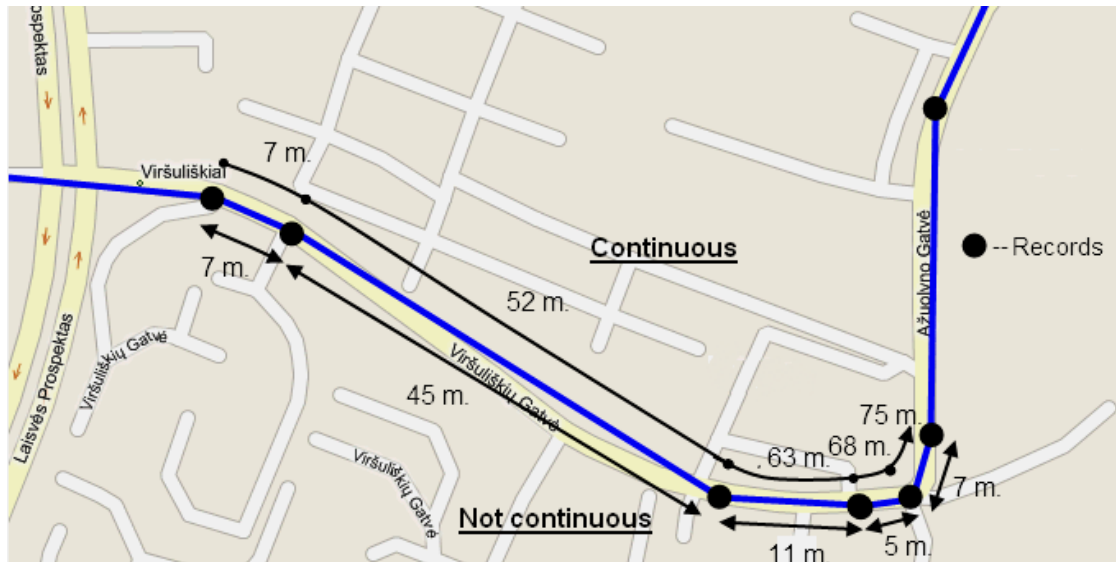

Figure 20 Trip continuous distance counting parameter example

5.9 AutoGeofencing settings

AutoGeofence – the last known position after movement = off. If your car's being taken away – you can be notified. The shape and size of the geofence zones are

parameters. It is possibility to state whether entering in or out of the geofence triggers an asynchronous message.

AutoGeofencing option can be configured by following parameters visible in figure 28 below.

Activation TMO – Time period before Geofence is activated after vehicle stops.

Deactivate By:

Ignition – If ignition becomes high it will disable AutoGeofence Zone;

Power Voltage – if power voltage enters entered value it will disable AutoGeofence Zone.

Digital input 1 – if digital input is triggered it will disable AutoGeofence Zone.

Feature – Priority of generated event, which will be applied to saved record.

Enter Event – Event generation on Geofence entrance.

Exit Event – Event generation on Geofence exit.

On Both - Event generation on Geofence entrance Or exit

Eventual Records – Enable or Disable Eventual Records functionality.

Note that AutoGeofencing does not require entering coordinates, instead it requires GPS visibility. If vehicle stopped and activation timeout has passed, an AutoGeofence will be created around vehicle's last position with set Radius value.

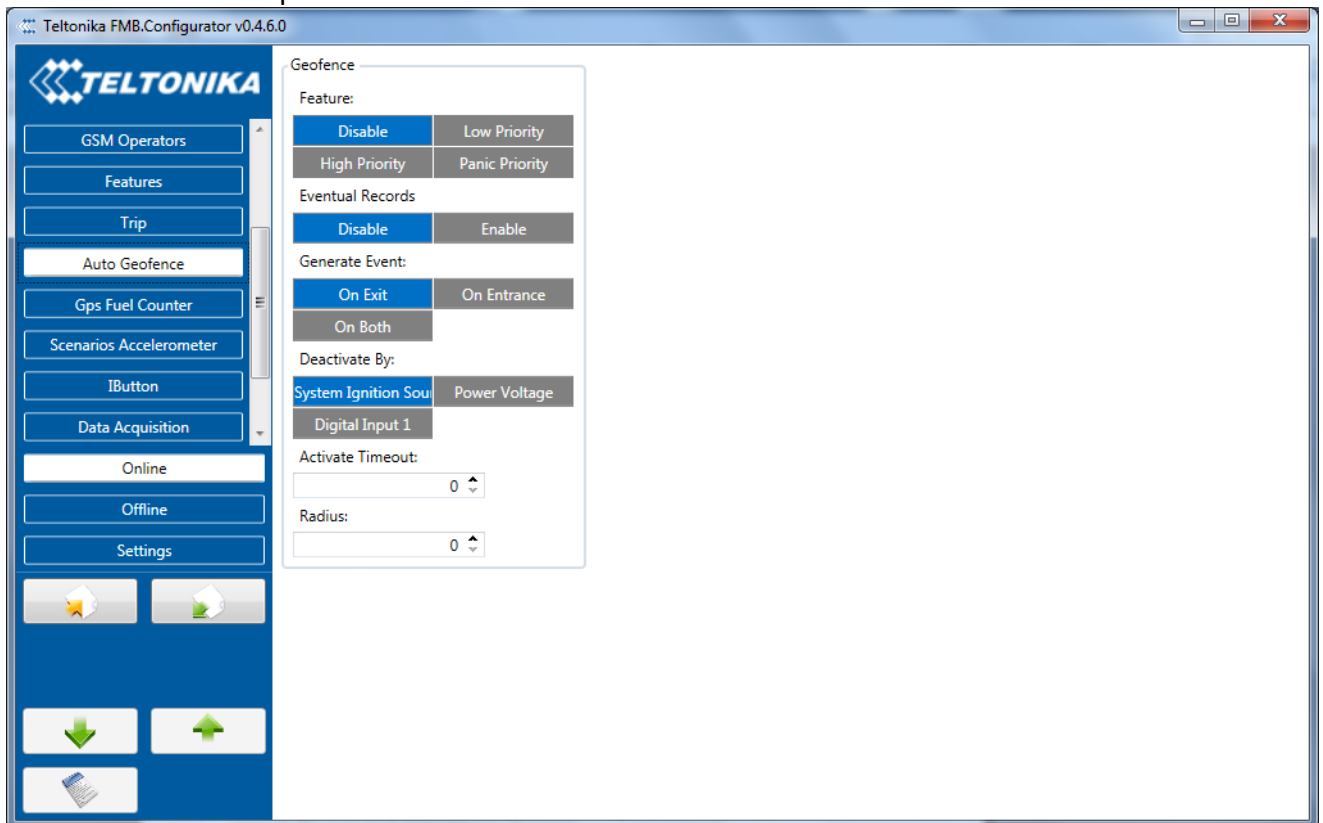

Figure 21 Geofence configuration

5.10 GPS Fuel Counter

GNSS Fuel Counter

City Consumption (l/100km)	0
Highway Consumption (l/100km)	0
Average Consumption (l/100km)	0
City Speed (km/h)	30
Highway Speed (km/h)	90
Average Speed (km/h)	60
Correction Coefficient	1
Fuel Consumption on Idling (l/h)	1
Higher Speeds add (%)	20
Highway Consumption every (km/h)	50

Configuration of Fuel Consumption

- To configure this parameters use fuel consumption norm which are presented in your car technical documentation. By default speeds for this fuel consumption norms are: City – 30 km/h, Average - 60km/h, Highway - 90 km/h. If you want, you can change it.
- When speed are higher than highway fuel consumption speed, we add for highway fuel consumption x % of highway fuel consumption every y km/h, by default FMB900 add 20% every 50 km/h. It means that fuel consumption is $(1.2 * \text{Highway Fuel Consumption})$ on 140 km/h speed, $(1.4 * \text{Highway Fuel Consumption})$ on 190 km/h speed.
- Correction coefficient is use for correction every value of fuel consumption which is send to server (Used Fuel * Correction coefficient). By default it is 1, min 0.01 and max 2. For example when correction coefficient is 1 and FMB900 calculate that used fuel of 35 m distance is 20 ml, to server will be sent value: 20 ml, if correction coefficient is 1.2 to server will be sent value: $20 * 1.2 = 24$ ml.
- Fuel consumption on idling used to calculate fuel consumption when ignition is on, but vehicle speed is 0 km/h. By default it is 1 l/h, min 0 and max 5 l/h. Almost in all diesel cars this parameter is less than 1.0 l/h. In gasoline cars this parameter is about 1.5 – 2.0 l/h.

5.11 Scenarios Accelerometer

5.11.1 Towing Detection

- FMB900 activates towing function when these conditions are met:
- Ignition (configured Ignition Source) is OFF.
 - Activation Timeout (set in Towing detection features) is reached.

When Activation Timeout is reached and Ignition is still in OFF state, FMB900 monitors accelerometer data. If Acceleration or Angle value reaches configured threshold for configured Duration (in ms), check Ignition state. If Ignition is still OFF during configured "Ignition check after Event Timeout" time, then event is generated. If configured - sends sms event or makes a call. Function will be reactivated after FMB900 again detects change of Ignition state from ON to OFF.

Activation timeout – Activation timeout is time after which FMB900 turns ON Towing detection function if other requirement is met (Ignition OFF state detected). It is measured in minutes.

Ignition check after event – defines time period (in seconds) to check ignition state when Acceleration or Angle value reach. If towing event is generated during this time period, it is skipped. It allows to filter out redundant towing events while entering the car.

Make Call to – if function enabled makes call to specified phone number (configured in predefined numbers)

Acceleration, Angle – values used to detect towing when ignition is OFF

Duration – defines time period to check Acceleration, Angle values.

5.11.2 Crash Detection

Crash Detection functionality can be set according to these settings:

- Threshold (mg)
- Duration (ms)

If accident happens and FMB900 detects acceleration value higher than set threshold value during set time period, then device will generate an event. Threshold and duration values are set depending of accident power which you want to detect. FMB900 can detect a slight tapping on the device (Threshold=100mg, Duration=1ms) or can detect severe accident (Threshold=4000mg, Duration=5ms)..

Crash Trace operation

If trace is enabled FMB will collect acceleration data every 40 msec., and in the deep-sleep mode too. Buffer is big enough to hold data for 5 seconds and on Crash Event detection, records will be generated from this buffer, following these conditions:

- Every second,
- Acceleration changed more then > 50mG,

Data will be collected and records generated 5 seconds after the event using the same conditions.

Every generated record will have accelerometer X Y Z values included. Each record will have accurate timestamps in milliseconds.

Usually between 20 to 30 records is generated on crash event detection.

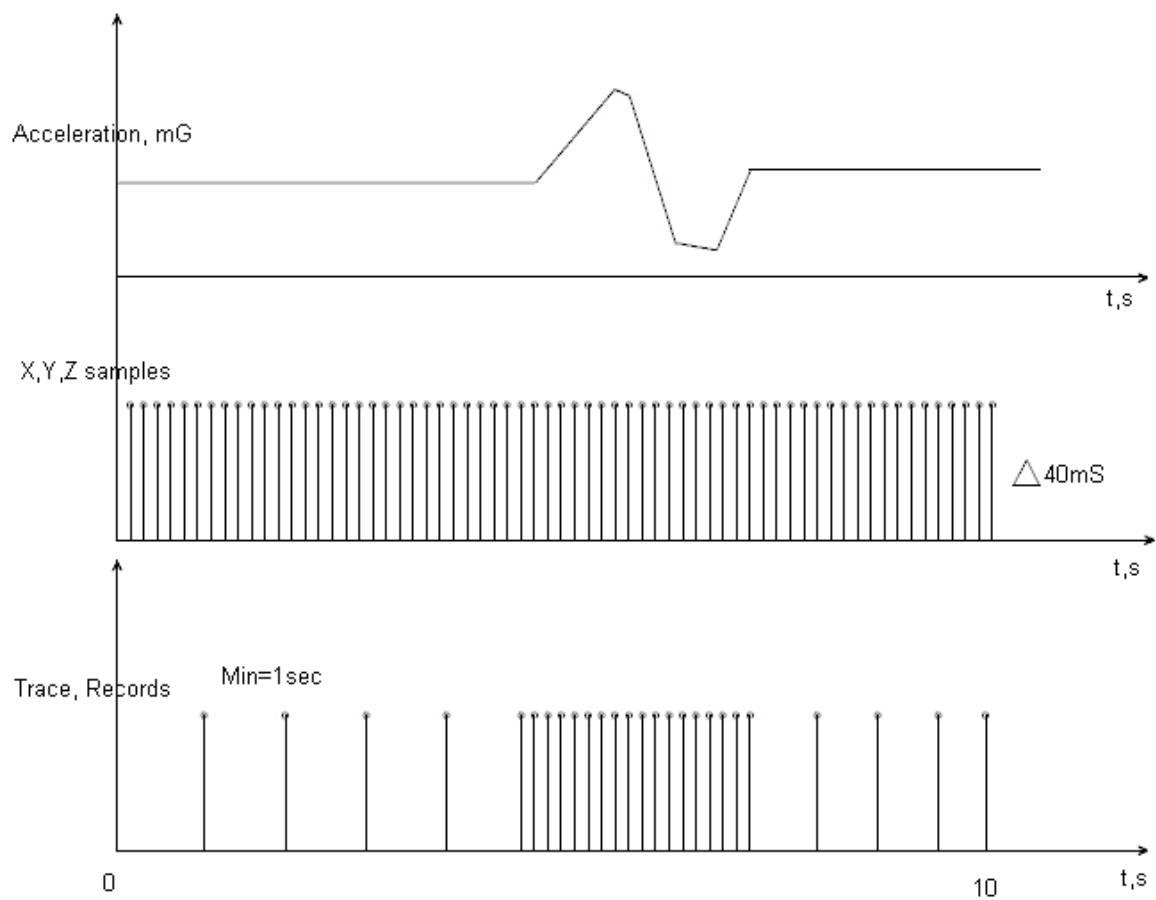

Figure 10 Example of Crash Trace logic

5.12 Bluetooth

General functionality

General

BT Radio

Disable	Enable (hidden)
Enable (visible)	

Local Name

Local PIN

Security Mode

PIN only	PIN + MAC list
MAC list only	None

Auto Connect to External Device

Connection Mode

None	Hands Free
OBDII	

External MAC

External Name

External PIN

Authorized Devices MAC List

1

2

3

4

5

Figure 24 Bluetooth general functionality

General functionality configures Bluetooth to work in *slave* mode. This mode allows any external device to connect to FMBXX.

Parameter *BT Radio* allows user to select if he wants to enable or disable Bluetooth. There is three different scenarios:

- Disabled – Bluetooth functionality will be disabled.
- Enable (hidden) – Bluetooth functionality will be enabled, but none of external devices will be able to detect FMBXX but will be able to connect.
- Enable (visible) – Bluetooth functionality will be enabled and any external device will be able to detect and connect to FMBXX.

Local Name parameter lets user to declare visible name of FMBXX to external devices. *Local PIN* parameter lets user to configure Bluetooth PIN of FMBXX device.

NOTE: FMBXX supports ONE connection at a time.

FMBXX Bluetooth has several different *security modes*:

- PIN only – while external device trying to connect to FMBXX only *Local PIN* will be required to complete connection.
- PIN + MAC list – while external device trying to connect to FMBXX *Local PIN* and *Authorized Devices MAC List* will be checked. If external device MAC ID is in the list and correct *Local PIN* is entered then connection will be established, else FMBXX will reject connection.
- MAC list only – while external device trying to connect to FMBXX only *Authorized Devices MAC List* will be checked. If external device MAC ID is in the list then connection will be established, else FMBXX will reject connection.

None – while external device trying to connect to FMBXX neither *Local PIN* or *Authorized Device MAC list* will be checked.

Auto Connection to External Device functionality

Auto connection functionality configures FMBXX as *master* device, this allows FMBXX connect to external device. FMBXX currently supports these modes:

- None – disables auto connection functionality.
- Hands Free – FMBXX starts to search external hands free headset. If FMBXX finds device which matches user defined *External MAC* or *External Name* then FMBXX will try to pair with that external device. If external device asks for PIN then FMBXX will send user defined *External PIN*. After successful pairing FMBXX will connect to paired device.

NOTE: FMBXX supports ONE connection at a time.

- OBDII – FMBXX starts to search external OBDII Bluetooth dongle. If FMBXX finds device which matches user defined *External MAC* or *External Name* then FMBXX will try to pair with that external device. If external device asks for PIN then FMBXX will send user defined *External PIN*. After successful pairing FMBXX will connect to paired device.

NOTE: FMBXX supports ONE connection at a time.

- Data Link – BT Data link mode is enabled by Configurator “Data Link” parameter: When Data Link is configured and FMB has a link with server, paired device could send messages via Bluetooth SPP profile directly to server. Messages will be encoded by codec12.

External Name parameter works as substring, this allows user to enter part of the full external device name. For example, if external device name is "HandsFreeHeadset" and user enters "HandsFree" in *External Name* parameter window then FMBXX will be allowed to connect to external device named "HandsFreeHeadset".

5.13 How to connect Bluetooth Hands Free adapter to FMB device

5.13.1 Bluetooth settings configuration

These are instructions how to easily prepare Bluetooth Hands Free device connection to FMB device. First we need to configure FMB device Bluetooth settings for proper connection to this hands-free unit. These are required steps:

1. Connect FMB device to PC using USB cable.
2. Launch **FMB Configurator** and connect to device as shown in **Figure 1** below.

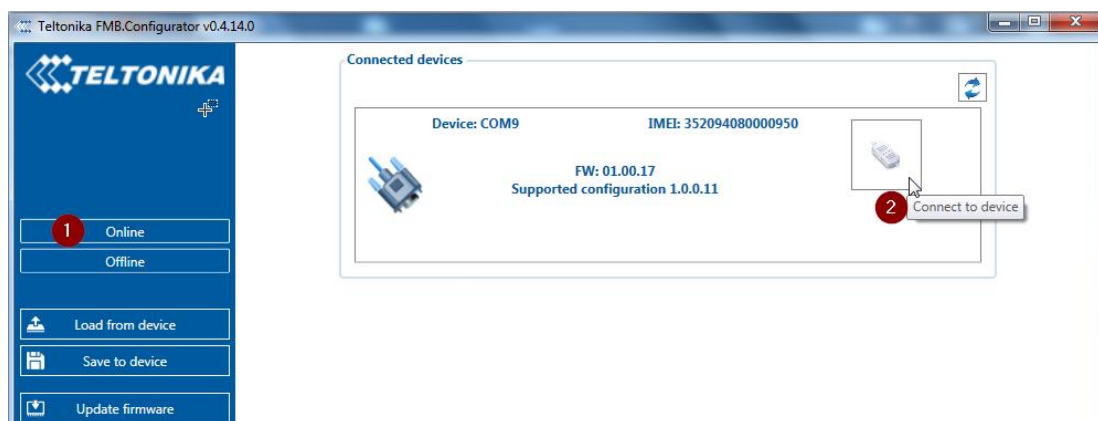

Figure 1. FMB configurator connected devices window

3. After successful connection to device press "Load from device" button to load device current configuration visible at **Figure 2.1**

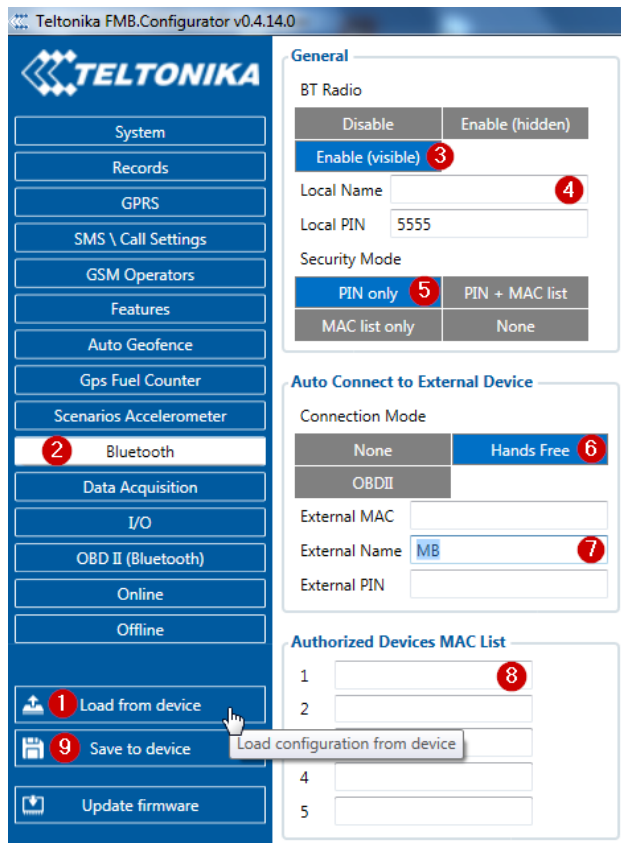

Figure 2.1 Load configuration from device; **2.2** Bluetooth settings; **2.3** Enable Bluetooth; **2.4** Bluetooth local name; **2.5** Bluetooth security mode **2.6** Hands Free connection mode; **2.7** External Bluetooth device name; **2.8** Authorized Devices MAC List; **2.9** Save device configuration

4. When device configuration is loaded press „**Bluetooth**“ settings (**Figure 2.2**).
5. Turn on BT Radio by pressing „**Enable (visible)**“ (**Figure 2.3**). You could leave “**Local name**” (**Figure 2.4**) box empty (then device name will automatically be “FMBxx_last 7 imei digits”) or type your own name.
6. Set Security Mode (**Figure 2.5**) to “**PIN only**” or “**None**” (you could select “**PIN + MAC list**” or “**MAC list only**” security mode but in this case you need to type external device MAC address in “**Authorized Devices MAC List**” (**Figure 2.8**).
7. Set connection mode to “**Hands Free**” (**Figure 2.6**).
8. Set „**External Name**“ as your Hands Free device name for proper device identification and connection to it. In this example Hands Free headset name is „MBH10“ but at least 2 characters are needed to recognize it and connect to it. For better and faster adapter identification in network you could enter a full device name. You could check your Hands Free adapter Bluetooth name by scanning nearby Bluetooth devices using mobile phone or computer with Bluetooth adapter.
9. Go to “**SMS \ Call Settings**” in left menu and set “**Incomming Call Action**” to “**Do Nothing**” visible at **Figure 3**.

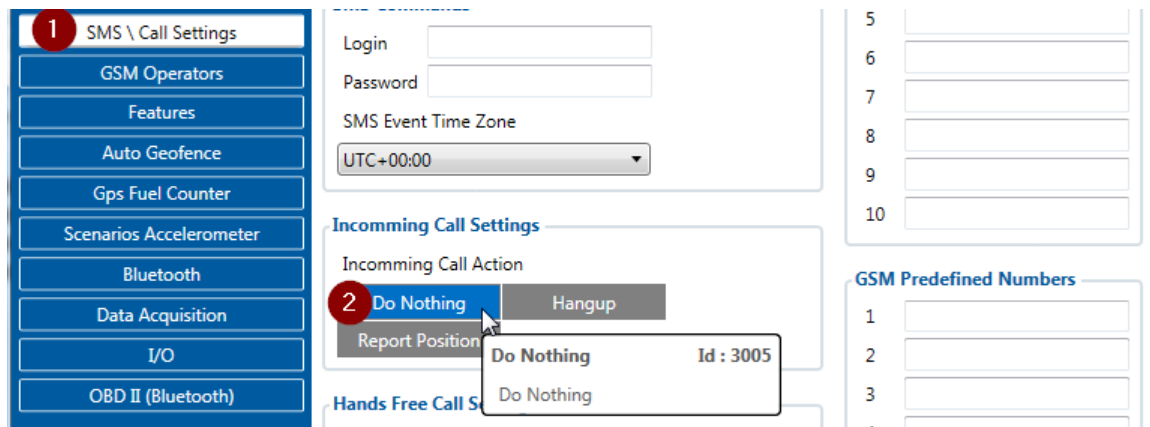

Figure 3. Incomming Call Action settings.

10. After all these steps press „**Save to device**“ to save configuration (**Figure 2.9**).
11. Now you can disconnect FMB device from a PC or stay connected if you want to make further changes to configuration.

5.13.2 Connecting Bluetooth Hands Free adapter

After this configuration you could connect your Hands Free device to FMB device. Turn on Hands Free device then turn on its Bluetooth connection for pairing following your model instructions⁴. Hands Free adapter should make a special sound in ear from speaker or its led identification should change to inform about successful connection⁵. To check if adapter is successfully connected, call to FMB device, Hands Free device should start ringing. If you later restart FMB device it will automatically connect to this adapter.

5.14 Device's log using your mobile phone.

When FMB device starts, automatically Bluetooth is ON too. Take your mobile phone, go to settings>Bluetooth and turn it on. Scan for near by devices, find you device in list, distinguish device by last IMEI numbers on device module. Press pair, wait until device will ask to enter pairing password, type: 5555. Paired device will show up in paired device list. Now download from play store/app store terminal for Bluetooth. E.g BlueTerm. Run app, click find>connect to your paired device. Now we need to send command to FMB9XX through Bluetooth terminal, type: .log:1

Device will respond Debug enabled and FMB9XX log will how up. Do not forget to start save log file to mobile phone.

⁴ Hands Free device Bluetooth connection pairing instructions depends on specific model.

⁵ Hands Free device notification about paired Bluetooth connection depends on specific model.

5.15 Device debug over Android smartphone

1. Scan for visible BT devices using your Android smartphone and connect to your FMB device.

Default FMB BT name: **FMBxx_last_7_imei_digits**

Default PIN code: **5555**

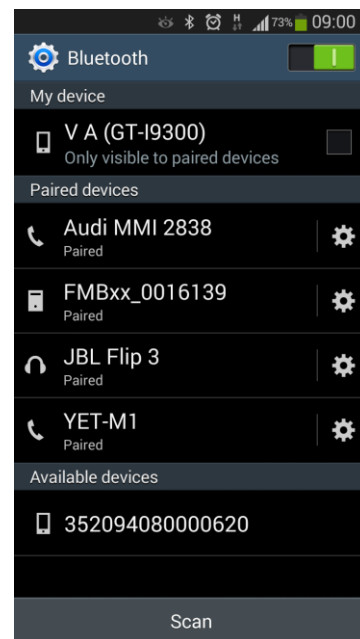

2. Download “Bluetooth Terminal” application. You can use link or QR code shown here:

<https://play.google.com/store/apps/details?id=com.hatfibs.btt>



3. Run Bluetooth Terminal. In menu press “Connect” button and select paired FMB device. To start log check CR and enter the command in terminal: **.log:1**



4. Wait ~10 minutes and press “Save” button in menu. You will find saved log file in device

folder (My Files/BluetoothTerminal), select log files and press button Share via Email and send them to the Teltonika support.

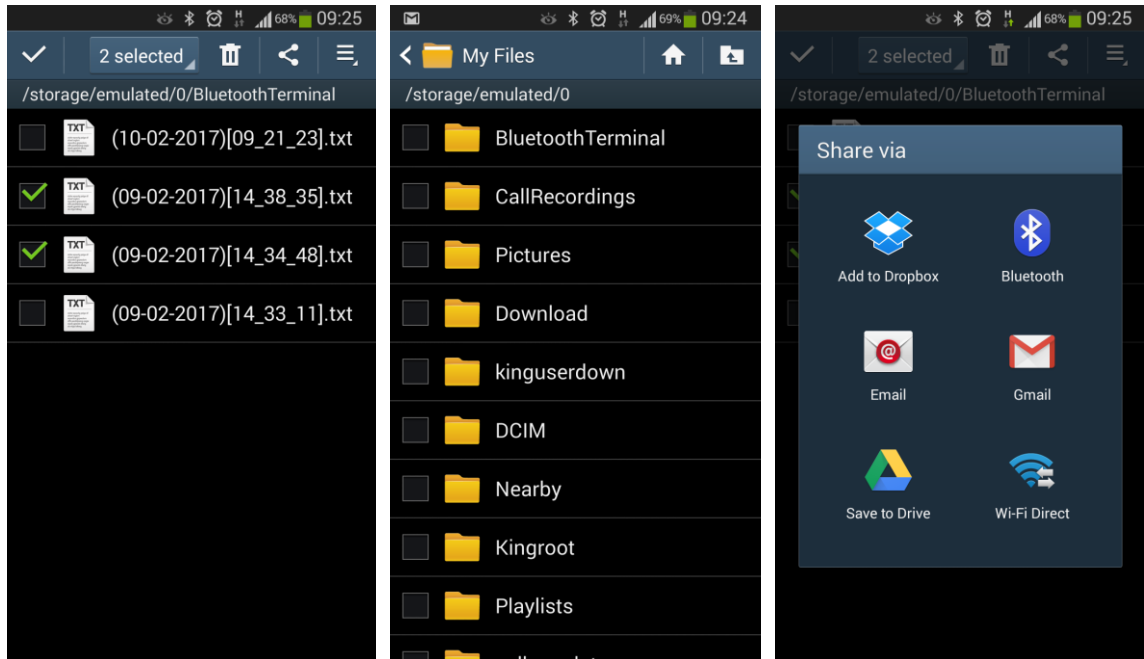

In order to pair FMB device with Android smartphone, make sure that BT radio is enabled (visible) in device configuration. It can be checked via SMS command too:

getparam 800

The answer has to be 2, which means "Enabled and visible".

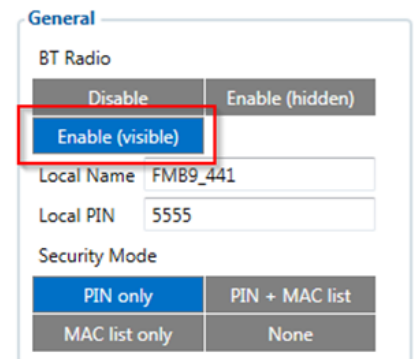

Note: Unfortunately it is not possible to do the same on iPhone, because there is no native SPP Bluetooth profile support in iPhone.

5.16 How to connect OBD II Bluetooth Dongle to FMB device

5.16.1 Bluetooth settings configuration

These are instructions how to easily prepare Bluetooth Dongle connection to FMB device. First we need to configure FMB device Bluetooth settings for proper connection to this unit. These are required steps:

1. Connect FMB device to PC using USB cable.
2. Launch **FMB Configurator** and connect to device as shown in **Figure 1** below.



Figure 1. FMB configurator connected devices window

3. After successful connection to device press “**Load from device**” button to load device current configuration visible at **Figure 2.1**

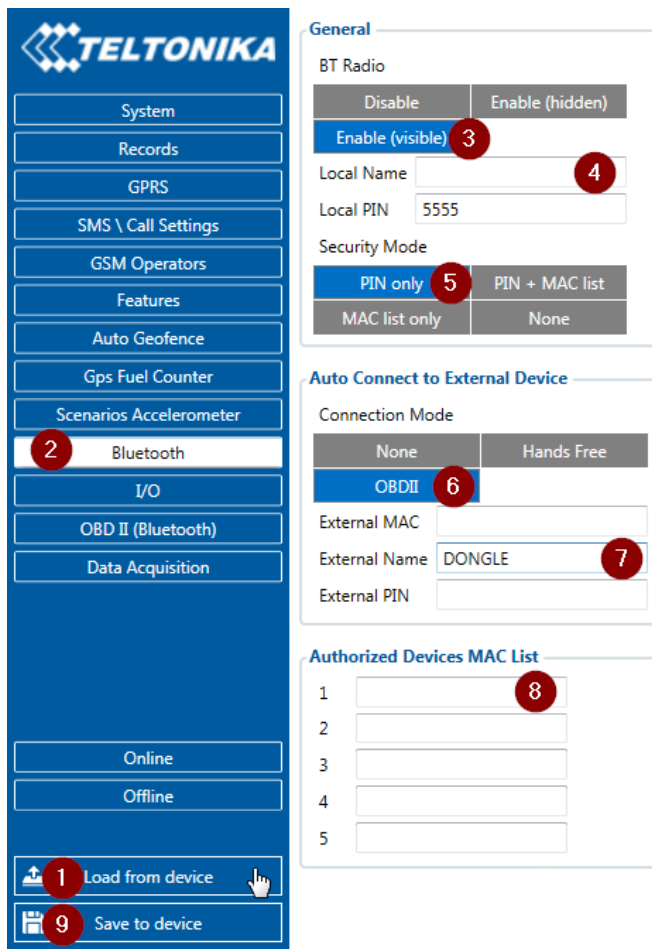

Figure 2.1 Load configuration from device; **2.2** Bluetooth settings; **2.3** Enable Bluetooth; **2.4** Bluetooth local name; **2.5** Bluetooth security mode **2.6** OBD II connection mode; **2.7** External OBD II Bluetooth device name; **2.8** Authorized Devices MAC List; **2.9** Save device configuration

4. When device configuration is loaded press „**Bluetooth**“ settings (**Figure 2.2**).
5. Turn on BT Radio by pressing „**Enable (visible)**“ (**Figure 2.3**). You could leave “**Local name**” (**Figure 2.4**) box empty (then device name will automatically be “FMBxx_last 7 IMEI digits”) or type your own name.
6. Set Security Mode (**Figure 2.5**) to “**PIN only**” or “**None**” (you could select “**PIN + MAC list**” or “**MAC list only**” security mode but in this case you need to type external device MAC address in “**Authorized Devices MAC List**” (**Figure 2.8**).
7. Set connection mode to “**OBDII**” (**Figure 2.6**).
8. Set „**External Name**“ as your Bluetooth OBD II device name for proper device identification and connection to it. In this example OBD II device name is „DONGLE“ but at least 2 characters are needed to recognize it and connect to it. For better and faster adapter identification in network you could enter a full device name. You could check your OBD II adapter Bluetooth name by scanning nearby Bluetooth devices using mobile phone or computer with Bluetooth adapter.
9. Go to “**OBD II (Bluetooth)**” in left menu and select priority and others parameters visible at **Figure 3**.

TELTONIKA		OBD II (Bluetooth)											
Input name	Units	Priority	Low level				High level		Event only		Operand	Send SMS to	SMS Text
Number Of DTC		None	Low	High	Panic	0	0	Yes	No	Monitoring			
Engine Load	%	None	Low	High	Panic	0	0	Yes	No	Monitoring			
Coolant Temperature	°C	None	Low	High	Panic	0	0	Yes	No	Monitoring			
Short Fuel Trim	%	None	Low	High	Panic	0	0	Yes	No	Monitoring			
Fuel Pressure	kPa	None	Low	High	Panic	0	0	Yes	No	Monitoring			
Intake MAP	kPa	None	Low	High	Panic	0	0	Yes	No	Monitoring			
Engine RPM	rpm	None	Low	High	Panic	0	0	Yes	No	Monitoring			
Vehicle speed	km/h	None	Low	High	Panic	0	0	Yes	No	Monitoring			
Timing advance	°	None	Low	High	Panic	0	0	Yes	No	Monitoring			
Intake air temperature	°C	None	Low	High	Panic	0	0	Yes	No	Monitoring			
MAF	g/sec	None	Low	High	Panic	0	0	Yes	No	Monitoring			
Throttle position	%	None	Low	High	Panic	0	0	Yes	No	Monitoring			
Run time since engine start	s	None	Low	High	Panic	0	0	Yes	No	Monitoring			
Distance traveled MIL on	km	None	Low	High	Panic	0	0	Yes	No	Monitoring			
Relative fuel rail pressure	kPa	None	Low	High	Panic	0	0	Yes	No	Monitoring			
Direct fuel rail pressure	kPa	None	Low	High	Panic	0	0	Yes	No	Monitoring			
Commanded EGR	%	None	Low	High	Panic	0	0	Yes	No	Monitoring			
EGR error	%	None	Low	High	Panic	0	0	Yes	No	Monitoring			
Fuel level	%	None	Low	High	Panic	0	0	Yes	No	Monitoring			
Distance traveled since codes clear	km	None	Low	High	Panic	0	0	Yes	No	Monitoring			
Barometric pressure	kPa	None	Low	High	Panic	0	0	Yes	No	Monitoring			
Control module voltage	V	None	Low	High	Panic	0	0	Yes	No	Monitoring			
Absolute load value	%	None	Low	High	Panic	0	0	Yes	No	Monitoring			
Ambient air temperature	°C	None	Low	High	Panic	0	0	Yes	No	Monitoring			
Time run with MIL on	min	None	Low	High	Panic	0	0	Yes	No	Monitoring			
Time since trouble codes cleared	min	None	Low	High	Panic	0	0	Yes	No	Monitoring			
Absolute fuel rail pressure	kPa	None	Low	High	Panic	0	0	Yes	No	Monitoring			
Hybrid battery pack remaining life	%	None	Low	High	Panic	0	0	Yes	No	Monitoring			
Engine oil temperature	°C	None	Low	High	Panic	0	0	Yes	No	Monitoring			
Fuel injection timing	°	None	Low	High	Panic	0	0	Yes	No	Monitoring			

Figure 3. OBD II Bluetooth settings.

10. After all these steps press „**Save to device**“ to save configuration (Figure 2.9).

11. Now you can disconnect FMB device from a PC or stay connected if you want to make further changes to configuration.

5.16.2 Connecting to Bluetooth OBD II dongle

After this configuration you could connect your car OBD II dongle to FMB device. Turn on ignition then turn on its Bluetooth connection. For pairing follow your dongle instructions⁶. OBD II device notification about paired Bluetooth connection depends on specific model. If you later restart FMB device it will automatically connect to this dongle.

5.16.3 Supported Bluetooth OBD II dongles

FMB module works with Bluetooth OBD II dongles which are made with **ELM327** or **STN1110** chips.

⁶ OBD II dongle Bluetooth connection pairing instructions depends on specific model.

Comparison of these chips is presented in **Figure 4**.

	ELM327 v1.4	STN1110
Base microcontroller	PIC18F2580	PIC24HJ128GP502
Architecture	8-bit	16-bit
Processing speed	4 MIPS	40 MIPS
Flash (ROM)	32 KB	128 KB
RAM	1.5 KB	8 KB
Pin count	28	28
Available packages	PDIP, SOIC	PDIP, SOIC, QFN
Supply voltage range	4.5 to 5.5V	3.0 to 3.6V ¹
Supports all OBD-II protocols	yes	yes
ELM327 command set	yes	yes
Enhanced "ST" command set	no	yes
Firmware upgradeable	no	yes
Large OBD message memory buffer	no	yes
Low power mode	yes	yes
Supported UART baud rates	9600 bps to 500 kbps	38 bps to 10 Mbps
OBD message filtering	basic	advanced

Figure 4. ELM327 and STN1110 comparison.

5.17 SMS events

SMS events functionality allows FMB900 to send a configured SMS when an event is triggered. This event can be triggered by ever I/O element.

Then any of the I/O elements is triggered, FMB900 sends a configured SMS message to a defined phone number. If SMS events is activated, but there are no numbers defined in SMS events PreDefined Numbers list (figure 22), then the device will not send any messages.

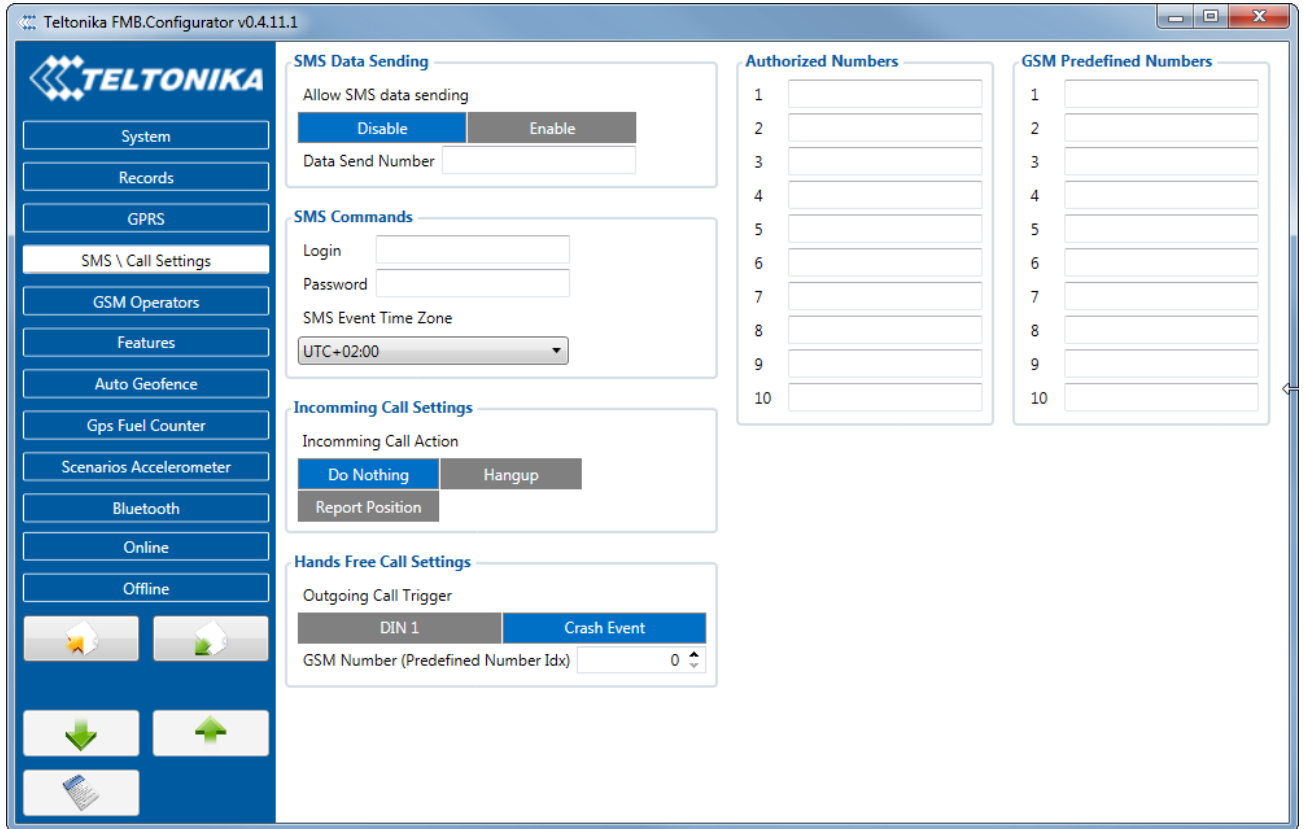

Figure 22 SMS Events PreDefined Numbers list

The sent SMS messages format is according to:

“Date Time EventText”

For example, if FMB900 is configured to send an SMS, when Ignition reaches High level, with priority High and configured to generate event on both range enter and exit (figure 23), then the sent SMS is:

“2012/6/7 12:00:00 Ignition 1”

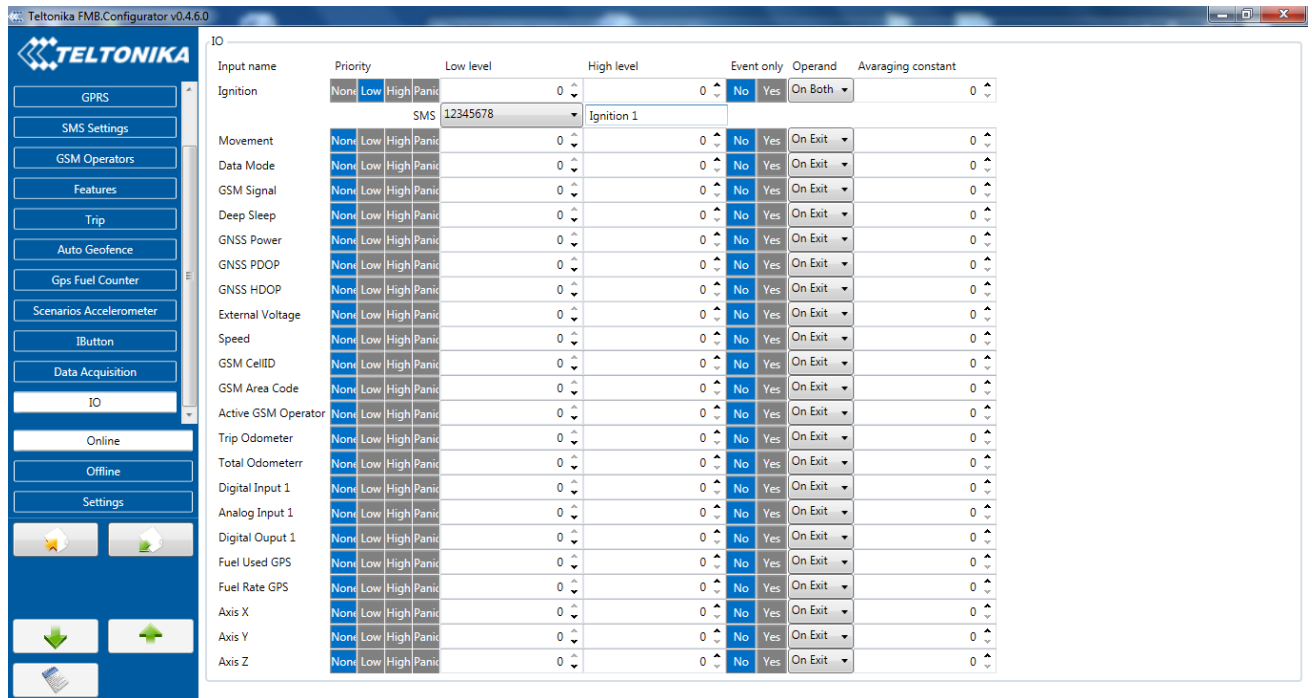

Figure 23 Configured Ignition SMS event

The SMS Text field can be altered and any text can be entered. Maximum message length is 90 symbols (numbers, letters and symbols in ASCII, except for comma “,”).



ATTENTION!

If FMB900 is in Deep Sleep mode and SMS event occurs with LOW priority (which does not wake up FMB900), then the device does not send the message. It is saved in device memory until it wakes up from Deep Sleep mode and GSM modem starts working normally. After it wakes up, all the messages that are saved in memory will be sent, but keep in mind that only 10 messages can be saved in memory – all other messages will not be saved, until there is room in device memory.

5.18 I/O settings

When no I/O element is enabled, AVL packet comes with GNSS information only. After enabling I/O element(s) AVL packet along with GNSS information contains current value(s) of enabled I/O element.

Enabled or disabled field – allows enabling I/O element so it is added to the data packet and is sent to the server. By default all I/O element are disabled and FMB900 records only GNSS coordinates.

Priority (AVL packet priority) all records made by FMB900 are regular. Regular packets are sent as Low priority records. When low priority event is triggered, FMB900 makes additional record with indication that the reason for that was I/O element change.

Table 3 Permanent I/O elements

Permanent I/O elements

(are always sent to server if enabled)		
Nr.	Property Name	Description
1	Ignition	Logic: 0 / 1
2	Movement	Logic: 0 / 1
3	Data mode	0 – home on stop, 1 – home on move, 2 – roaming on stop, 3 – roaming on move, 4 – unknown on stop, 5 – unknown on move
4	GSM signal	GSM signal level value in scale 1 – 5
5	Deep sleep	Logic: 0 / 1
6	GNSS power	States: 0 – short circ., 1 – connected. Parameter defines if GPS antenna is short circuit. All the time value will be sent 1. The only condition to get value 0, then antenna is damaged and short circuit.
7	GNSS PDOP	Probability * 10; 0-500
8	GNSS HDOP	Probability * 10; 0-500
9	External Voltage	Voltage: mV, 0 – 30 V
10	Speed	Value in km/h, 0 – xxx km/h
11	GSM Cell ID	GSM base station ID
12	GSM Area Code	Location Area code (LAC), it depends on GSM operator. It provides unique number which assigned to a set of base GSM stations. Max value: 65536
13	Active GSM operator	Currently used GSM Operator code
14	Trip odometer	Distance between two records: m
15	Total odometer	Total odometer count: m
16	Cell ID	GSM base station ID
17	Digital Input 1	Logic: 0 / 1
18	Analog Input 1	Voltage: mV, 0 – 30 V
19	Digital output 1	Logic: 0 / 1
20	Fuel Used GPS	Fuel used (ml) by GPS
21	Fuel Rate GPS	Fuel Consumption by average speed (l/100km)
22	Axis X	Accelerometer axis x value
23	Axis Y	Accelerometer axis y value
24	Axis Z	Accelerometer axis z value

6 SMS COMMAND LIST

All commands are case sensitive. While FMB900 operates in Sleep mode and user tries to send SMS message it will arrive to FMB900 device, because GSM module is enabled. Only GNSS module is disabled in sleep mode.

6.1 SMS command list

Table 4 SMS commands

Command	Description	Response
---------	-------------	----------

getinfo	Device runtime system information	Yes
getver	Returns code version, device IMEI, modem app version, RTC time	Yes
getstatus	Returns Data Link:0 GPRS:0 Phone:0 SIM:0 OP:24602 Signal:5 NewSMS:0 Roaming:0 SMSFull:0 LAC:0 Cell ID:0	Yes
getgps	Returns GPS status, Satellite number, Latitude, Longitude, Altitude, Speed, Date, Time	Yes
ggps	Returns location information with Google maps link	Yes
readio	Returns IO status	Yes
cpureset	Resets device	No
getparam	Returns selected parameter value	Yes
setparam	Sets selected parameter value	Yes
flush	Redirects device to other server	Yes
countrecs	Returns record number	Yes
setdigout X Y	Set digital output X – 0 or 1 (0 - OFF or 1 – ON) Y – timeout value if needed (in seconds)	Yes
fc_reset	Resets fuel consumption parameters	Yes
towingreact	Towing reactivation	Yes
btgetlist	Returns requested Bluetooth list(values:0, 1, 2)	Yes
btgscan	Starts Bluetooth scan(values: none, 1)	Yes
btvisible	Sets Bluetooth to visible with TMO	Yes
btrelease	Disconnects from current device and pauses auto connect functionality for TMO	Yes
btunpair	Unpair Bluetooth device	Yes

Setparam and setdigout SMS is used to configure device.

Parameter ID consists of 3 or 5 digits. Detailed list of parameters and IDs can be found in chapter number 5.2 “System parameters”

Example: **‘username password setparam 102:0’** will disable sleep mode.

Example: **‘username password setparam 2001:wap;2002:user;2003:pass’** will change configured APN name, APN username and APN password. SMS command of limited to 160 characters.

Example: **‘username password setdigout 1 60’** will set digital output ON for 60s.

6.1.1 getinfo

Response details	Description
RTC	RTC Time
INI	Device Initialization Time
UpTime	Operating time since last restart
PWR	Start-up / restart reason
RST	Restart Counter
GPS	GPS receiver state. 0 – OFF, 1 – restarting, 2 – ON but no fix, 3 –

	ON and operational, 4 – sleep mode
SAT	Average satellites
TTFF	Time to first fix
NOGPS	No GPS Timer
SR	Number of Sent Records
FG	Failed GPRS counter
FL	Failed link counter
SMS	Sent SMS Counter
REC	Records Found – number of records in the memory.
MD	Data Mode state. 0 – Home and Stop, 1 – Home and Moving, 2 – Roaming and Stop, 3 – Roaming and Moving, 4 – Unknown and Stop, 5 – Unknown and Moving

Example: RTC:2017/5/23 12:49 Init:2017/5/23 11:18 UpTime:5446s PWR:PwrVoltage RST:0 GPS:1 SAT:0 TTFF:3939 NOGPS:1:24 SR:0 FG:229 FL:0 SMS:2 REC:15 MD:0

6.1.2 getver

Response details	Description
App Ver	Firmware version
Modem Ver	Version of modem application
GPS Ver	Version of GPS module
Hw Ver	Version of hardware
Device IMEI	IMEI

Example: App Ver:01.00.17 Rev:01 Modem Ver:TM25Q_D_01.00.00.00_010 GPS Ver:AXN_3.82_3333_1Hw Ver:FMB9_MOD2_A0:B0:C1:D0 Device IMEI:352094080000950

6.1.3 getstatus

Response details	Description
Data Link	Indicate module connection to server at the moment: 0 – Not connected, 1 – connected
GPRS	Indicate if GPRS is available at the moment
Phone	Voice Call status: 0 – ready, 1 – unavailable, 2 – unknown, 3 –ringing, 4 – call in progress, 5 – asleep
SIM	SIM Status: 0-ready, 1-pin, 2-puk, 3-pin2, 4-puk2
OP	Connected to GSM Operator: numerical id of operator
Signal	GSM Signal Quality [0-5]
NewSMS	Indicate if new message received
Roaming	0 – Home Network, 1 – roaming
SMSFull	SMS storage is full? 0 – ok, 1 – SMS storage full
LAC	GSM Tower Location Area Code
Cell ID	GSM Tower Cell ID Code

Example: Data Link: 0 GPRS: 1 Phone: 0 SIM: 0 OP: 24602 Signal: 5 NewSMS: 0 Roaming: 0 SMSFull: 0 LAC: 1 Cell ID: 3055

6.1.4 getgps

Response details	Description
GPS	Indicates valid (1) or invalid (0) Gps data
Sat	Count of currently available satellites
Lat	Latitude (Last good Latitude)
Long	Longitude (Last good Longitude)
Alt	Altitude
Speed	Ground speed, km/h
Dir	Ground direction, degrees
Date	Current date
Time	Current GMT time

Example: GPS:1 Sat:0 Lat:54.666042 Long:25.225031 Alt:0 Speed:0 Dir:0 Date: 17/1/9 Time: 12:52:30

6.1.5 ggps

Response details	Description
D	Date
T	Time
S	Actual Speed
C	Latitude (Last good Latitude), Longitude (Last good Longitude)
Url	Google Maps Link

Example: D:17/1/9 T:12:52:30 S:0.00 C:54.666042, 25.225032 Url: <http://maps.google.com/?q=54.666042,25.225032&om=1speed:0>

6.1.6 readio

Response details	Description
ID	I/O element ID
Value	I/O Element value

Example: Param ID:3 Value:0

6.1.7 getparam

Read parameter value. ID consists of 3 or 4 digits. A detailed list of parameters and identifiers can be found in this chapter next later.

Example: ,getparam 2001' command will request APN name

Answer: Param ID:2001 Value:wap

6.1.8 setparam

Read parameter value. ID consists of 3 or 4 digits. A detailed list of parameters and identifiers can be found in this chapter next later.

Example: ,setparam 2001:wap' will change configured APN name

Answer: Param ID:2001 Value:wap2

Example: 'setparam 2001:wap;2002:user;2003:pass' will change configured APN name, APN username and APN password. SMS command of limited to 160 characters.

6.1.9 flush #,#,#,#,#,#,#

Initiates all data sending by GPRS to specified target server. Comma separated parameters go as numbered:

- 1.# - IMEI
- 2.# - APN
- 3.# - GPRS LOGIN
- 4.# - GPRS PASSWORD
- 5.# - IP
- 6.# - PORT
- 7.# - MODE (0-TCP/1-UDP)

Parameters are separated by comma (no spaces needed). In case you don't need to enter parameter (Login/Pass) – do not put space, simply put comma and write next parameter.

Example: opa opa flush 353976012555151,banga,,,212.47.99.62,12050,0

Response details	Description
FLUSH SMS Accepted	FLUSH SMS Accepted
# records found on FLASH	Number of records found on FLASH
Minimum Records to Send: #	Number of minimum saved records to send
GPRS Enabled: #	State of the GPRS connection, 0 – disabled; 1 – enabled
Time Sync: #	Indicates time synchronization on the device, 0 – not synchronized; 1 – synchronized

Example: FLUSH SMS Accepted. 11 records found on FLASH. Minimum Records to Send: 1. GPRS Enabled: 1. Time Sync: 1.

6.1.10 setdigout

Sets digital output to ON or OFF state (timeout for output is controllable)

Example: 'setdigout 1 60' will set OUT to high level for 60 seconds,
'setdigout 1' will set OUT to high level for infinite time.

6.1.11 countrecs

Returns the number of records save in the Micro SD card.

6.1.12 towingreact

Reactivates Towing Detection to initial state (does not wait for ignition to be OFF). Useful when generated false Towing event and needs reactivation.

6.1.13 btgetlist

btgetlist command needs argument what list should be printed!

btgetlist 0; device will respond with BT_LIST_Discovered

btgetlist 1; device will respond with all paired devices

btgetlist 2; device will respond with connected bluetooth device

Note: Without argument it is always 0 i.e **BT_LIST_Discovered**
In FW 01.00.23 btgetlist (without args) will not respond (as unknown command)

6.2 System parameters

6.2.1 Sleep Mode (ID=102)

Device has two sleep modes: sleep and deep sleep mode. While sleep is disabled (value 0) module will never enter sleep mode, in sleep mode (value 1) module reduces level of power usage by turning GPS module to sleep, in deep sleep mode (value 2) module turns GPS module to sleep and device is deregistered from network (note, that FMB900 do not receive SMS while in deep sleep), online sleep mode (value 3) device works as in Deep Sleep mode, but without deregistering from GSM network. GSM part stays powered, so this increases power consumption. In this mode, device should received/send SMS and make/receive calls. Also not closes GPRS context, if previously opened.

Minimum value	Maximum value	Recommended value	Goes with (depends on) parameters	Value type
0	3	-		U8

6.2.2 Sleep timeout (ID=103)

Sleep timeout is time after which FMB900 goes to sleep or deep sleep if other requirements are met. It is measured in minutes.

Minimum value	Maximum value	Recommended value	Goes with (depends on) parameters	Value type
1	3000	-		U8

6.2.3 Movement Source (ID=100)

Device can operate and change its working mode according to motion detection source: ignition (value 0), movement sensor (value 1), GPS (value 2)

Minimum value	Maximum value	Recommended value	Goes with (depends on) parameters	Value type
0	2	-		U8

6.2.4 Static Navigation (ID=106)

When static navigation is enabled, FMB900 filters out GPS jumps, when it is not moving. When it is disabled, it does not make any changes to collected GPS data.

Minimum value	Maximum value	Recommended value	Goes with (depends on) parameters	Value type
0	1	1		U8

6.2.5 Saving/Sending without time synchronization (ID=107)

When this feature is enabled (value = 1), then records can be saved and sent to server without time synchronization.

Minimum value	Maximum value	Recommended value	Goes with (depends on) parameters	Value type
0	1	1		U8

6.2.6 GNSS Source (ID=109)

This parameter sets Satellite System, available values:

Undefined	value:0
Beidou only	value:1
Glonass only	value:2
Galileo only	value:4
Galileo+Beidou	value:5
Galileo+Glonass	value:6
GPS only	value:8
GPS+Beidou	value:9
GPS+Glonass	value:10
GPS+Galileo	value:12
GPS+Galileo+Beidou	value:13
GPS+Galileo+Glonass	value:14
GPS, Galileo, Glonass and Beidou and not allowed	value:15

Minimum value	Maximum value	Recommended value	Goes with (depends on) parameters	Value type
0	15	-		U8

6.2.7 Ignition settings (ID=101)

This parameter sets ignition source available values : 0 – Power voltage, 1 – Digital Input, 2– Accelerometer.

Minimum value	Maximum value	Recommended value	Goes with (depends on) parameters	Value type
0	2	0		U8

6.2.8 High voltage level (ID=104)

Sets high level of voltage if ignition settings is set to power voltage.

Minimum value	Maximum value	Recommended value	Goes with (depends on) parameters	Value type
0	30000	30000		U8

6.2.9 Low voltage level (ID=105)

Sets low level of voltage if ignition settings is set to power voltage.

Minimum value	Maximum value	Recommended value	Goes with (depends on) parameters	Value type
0	29999	13000		U8

6.2.10 Led indication (ID=108)

Sets led indication: 0 – disabled, 1 – enabled

Minimum value	Maximum value	Recommended value	Goes with (depends on) parameters	Value type
0	1	1		U8

6.2.11 Synchronization settings (ID=900)

Settings used for device internal time synchronization: 0 – GPS only, 1 – NITZ and NTP, 2 – NTP, 3 – NITZ.

Minimum value	Maximum value	Recommended value	Goes with (depends on) parameters	Value type
0	3	1		U8

6.2.12 NTP Resync (ID=901)

Periodical time synchronization. If not zero FMBxxx will resynchronize time once set period expires.

Minimum value	Maximum value	Recommended value	Goes with (depends on) parameters	Value type
0	24	1		U8

6.2.13 NTP server 1 (ID=902)

Minimum value	Maximum value	Recommended value	Goes with (depends on) parameters	Value type
Empty	55 char string	avl1.teltonika.lt		S8[55]

6.2.14 NTP server 2 (ID=903)

Minimum value	Maximum value	Recommended value	Goes with (depends on) parameters	Value type
Empty	55 char string	pool.ntp.org		S8[55]

6.3 Records parameters

6.3.1 Sorting (ID=1002)

Record sorting parameter is responsible for record sorting order. Value of 0 arranging data starting from newest, while value of 1 arranging data starting from oldest.

Minimum value	Maximum value	Recommended value	Goes with (depends on) parameters	Value type
0	1	-		U8

6.3.2 Open Link Timeout (ID=1000)

Defines for how many seconds device will keep connection to the server after successful data transfer while waiting for a new record.

Minimum value	Maximum value	Recommended value	Goes with (depends on) parameters	Value type
0	259200	-		U32

6.3.3 Server Response Timeout (ID=1001)

Defines time period (in seconds) for server response to sent records.

Minimum value	Maximum value	Recommended value	Goes with (depends on) parameters	Value type
5	300	-		U8



ATTENTION! Some GSM operators may disconnect the device from an active data link if the device doesn't send any data for a very long time, even if active data link timeout is set to maximum value. The amount of time that an operator keeps the link open depends solely on the operator. For example, if active data link timeout is set to maximum, 259200 seconds (72 hours), and the device sends data to server every 86400 seconds (24 hours), the operator might disconnect the link earlier and the device will have to connect to the server anew. This may cost extra, depending on the operator GPRS data charge. It is strongly recommended, when using active data link timeout, that data sending to the server should not be very rare (24 hours or more). If data sending is more frequent, then the operator will not disconnect the device from the server.

6.4 GSM parameters

6.4.1 GPRS content activation (ID=2000)

Parameter allows or does not allow GPRS usage. If GPRS is not allowed value is 0, if GPRS is allowed value is 1.

Minimum value	Maximum value	Recommended value	Goes with (depends on) parameters	Value type
0	1	-	APN Name (ID=2001) APN username (ID=2002) APN Password (ID=2003)	S8

6.4.2 APN Name (ID=2001)

Parameter defines GPRS Access Point Name.

Minimum	Maximum	Recommended	Goes with (depends on)	Value
---------	---------	-------------	------------------------	-------

value	value	value	parameters	type
Empty	32 char string	-	GPRS content activation (ID=2000) APN username (ID=2002) APN Password (ID=2003)	S8[32]

6.4.3 APN username (ID=2002)

Parameter defines APN username. In case operator does not use username for login, value should be empty.

Minimum value	Maximum value	Recommended value	Goes with (depends on) parameters	Value type
Empty	30 char string	-	GPRS content activation (ID=2000) APN Name (ID=2001) APN Password (ID=2003)	S8[30]

6.4.4 APN Password (ID=2003)

Parameter defines APN password. In case operator does not use password for login, value should be empty.

Minimum value	Maximum value	Recommended value	Goes with (depends on) parameters	Value type
Empty	30 char string	-	GPRS content activation (ID=2000) APN Name (ID=2001) APN username (ID=2002)	S8[30]

6.4.5 Domain (ID=2004)

Parameter defines AVL data destination server IP address. Example: 212.47.99.62

Minimum value	Maximum value	Recommended value	Goes with (depends on) parameters	Value type
0	54 char string	-	GPRS content activation (ID=2000)	S8[16]

6.4.6 Target Server Port (ID=2005)

Parameter defines AVL data destination server port number. Example: 12050

Minimum value	Maximum value	Recommended value	Goes with (depends on) parameters	Value type
Empty	65535	-	GPRS content activation (ID=2000)	U16

6.4.7 Protocol (ID=2006)

Parameter defines GPRS data transport protocol. Module can use TCP or UDP transport protocol to send data to server. For TCP protocol value is 0, for UDP protocol value is 1.

Minimum value	Maximum value	Recommended value	Goes with (depends on) parameters	Value type
0	1	-	GPRS content activation (ID=2000)	U8

6.5 SMS/Call settings

6.5.1 SMS data sending settings (ID=3000)

Parameter allows or does not allow sending AVL data using binary SMS. If SMS use is not allowed value is 0 and 1 if SMS use is allowed.

Minimum value	Maximum value	Recommended value	Goes with (depends on) parameters	Value type
0	1	-	Data send number (ID=3001)	

6.5.2 Data send number (ID=3001)

In this field are written GSM numbers, to which will be sent Data SMS.

Minimum value	Maximum value	Recommended value	Goes with (depends on) parameters	Value type
1 digit	16 digits	-		S8

6.5.3 Authorized phone numbers (ID=4000-4009)

If at least one number is entered then only those number can send messages to device. Number must be entered without "+" or "00".

Example: 37060012346

Minimum value	Maximum value	Recommended value	Goes with (depends on) parameters	Value type
1 digit	16 digits	-		S8[17]

6.5.4 SMS Event Predefined Numbers (ID=6000-6009)

In this field GSM numbers are written, to which will be sent "Event SMS" text message. Number must be entered without "+" or "00".

Example: 37060012346

6.5.5

SMS Login (ID=3003)

User login is used to ensure module security. Used in every SMS that is sent to device. Example: ba321

Minimum value	Maximum value	Recommended value	Goes with (depends on) parameters	Value type
Empty	5 char	-	SMS Password (ID=3004)	S8[5]

6.5.6 SMS Password (ID=3004)

User password is used to ensure module security. Used in every SMS that is sent to device.
Example: ab123

Minimum value	Maximum value	Recommended value	Goes with (depends on) parameters	Value type
Empty	5 char	-		S8[5]

6.5.7 Incoming call action (ID=3005)

Parameter defines action during call: 0 – do nothing, 1 – hang up, 2 – report position

Minimum value	Maximum value	Recommended value	Goes with (depends on) parameters	Value type
0	2	0		S8[17]

6.5.8 Outgoing Call Trigger (ID=3007)

Parameter defines hands free call trigger: 0 – Disable, 1 – DIN1, 2 – Crash event, 3 – DIN1 and Crash event.

Minimum value	Maximum value	Recommended value	Goes with (depends on) parameters	Value type
0	3	-		UInt64

6.5.9 GSM number index (ID=3008)

Parameter defines gsm number's, in predefined number list, index.

Minimum value	Maximum value	Recommended value	Goes with (depends on) parameters	Value type
1	10	-		UInt64

6.5.10 Operator List (ID=5000-5049)

Parameter defines operator list. According to this list module selects operating profile. First in a list is *Home Operator Code*, then Preferred Roaming Operator Codes are written.

Minimum value	Maximum value	Recommended value	Goes with (depends on) parameters	Value type
Empty	6 digits	-		U32

6.6 Data Acquisition Modes parameters

6.6.1 Home Network GSM operator code "Vehicle on STOP" parameters

6.6.1.1 Min Period (ID=10000)

This parameter indicates time interval in seconds in order to acquire new record. If value is 0 it means no records by min period will be saved.

Minimum	Maximum	Recommended	Goes with (depends on)	Value

value	value	value	parameters	type
0	2592000	-		U32

6.6.1.2 Min Saved Records (ID=10004)

This parameter defines minimum number of records in one data packet that can be sent to server. It has higher priority than Data Send Period (ID=10005).

Minimum value	Maximum value	Recommended value	Goes with (depends on) parameters	Value type
1	255	1		U8

6.6.1.3 Send Period (ID=10005)

This parameter indicates frequency (time interval in seconds) of sending data to server.

Minimum value	Maximum value	Recommended value	Goes with (depends on) parameters	Value type
0	2592000	-	Min Saved Records (ID=10004)	U32

6.6.2 Home Network GSM operator code "Vehicle MOVING" parameters

6.6.2.1 Min Period (ID=10050)

This parameter indicates time interval in seconds in order to acquire new record. If value is 0 it means no records by min period will be saved.

Minimum value	Maximum value	Recommended value	Goes with (depends on) parameters	Value type
0	2592000	-	Min Distance (ID=10051) Min Angle (ID=10052)	U32

6.6.2.2 Min Distance (ID=10051)

This parameter indicates distance in meters in order to acquire new record. Record is stored when the distance between previous records is greater than parameters value. If value is 0 it means no records by min distance will be saved.

Minimum value	Maximum value	Recommended value	Goes with (depends on) parameters	Value type
0	65535	-	Min Period (ID=10050) Min Angle (ID=10052)	U32

6.6.2.3 Min Angle (ID=10052)

This parameter indicates angle in degrees in order to acquire new record. If angle difference between last recorded coordinate and current position is greater than defined value, new record is stored. This parameter is operational, when speed is higher than 10km/h. If value is 0 it means no records by min angle will be saved.

Minimum value	Maximum value	Recommended value	Goes with (depends on) parameters	Value type
0	180	-	Min Period (ID=10050)	U16

			Min Distance (ID=10051)	
--	--	--	-------------------------	--

6.6.2.4 Min Speed delta (ID=10053)

This parameter indicates speed difference in order to acquire new record. If speed difference between last recorded coordinate and current position is greater than defined value, new record is stored. If value is 0 it means no records by min distance will be saved.

Minimum value	Maximum value	Recommended value	Goes with (depends on) parameters	Value type
0	255	10	Min Period (ID=10050) Min Distance (ID=10051) Min Angle (ID=10052)	U16

6.6.2.5 Min Saved Records (ID=10054)

This parameter defines minimum number of records in one data packet that can be sent to server. It has higher priority than Data Send Period (ID=10055).

Minimum value	Maximum value	Recommended value	Goes with (depends on) parameters	Value type
1	255	1	Min Period (ID=10050) Min Distance (ID=10051) Min Angle (ID=10052)	U8

6.6.2.6 Send Period (ID=10055)

This parameter indicates frequency (time interval in seconds) of sending data to server.

Minimum value	Maximum value	Recommended value	Goes with (depends on) parameters	Value type
0	2592000	-		U32

6.6.3 Roaming Network GSM operator code "Vehicle on STOP" parameters

6.6.3.1 Min Period (ID=10100)

This parameter indicates time interval in seconds in order to acquire new record. If value is 0 it means no records by min period will be saved.

Minimum value	Maximum value	Recommended value	Goes with (depends on) parameters	Value type
0	2592000	-		U32

6.6.3.2 Min Saved Records (ID=10104)

This parameter defines minimum number of records in one data packet that can be sent to server. It has higher priority than Data Send Period (ID=10105).

Minimum value	Maximum value	Recommended value	Goes with (depends on) parameters	Value type
1	255	1		U8

6.6.3.3 Send Period (ID=10105)

This parameter indicates frequency (time interval in seconds) of sending data to server.

Minimum value	Maximum value	Recommended value	Goes with (depends on) parameters	Value type
0	2592000	-	Min Saved Records (ID=10104)	U32

6.6.4 Roaming Network GSM operator code "Vehicle MOVING" parameters

6.6.4.1 Min Period (ID=10150)

This parameter indicates time interval in seconds in order to acquire new record. If value is 0 it means no records by min period will be saved.

Minimum value	Maximum value	Recommended value	Goes with (depends on) parameters	Value type
0	2592000	-	Min Distance (ID=10151) Min Angle (ID=10152)	U32

6.6.4.2 Min Distance (ID=10151)

This parameter indicates distance in meters in order to acquire new record. Record is stored when the distance between previous records is greater than parameter's value. If value is 0 it means no records by min distance will be saved.

Minimum value	Maximum value	Recommended value	Goes with (depends on) parameters	Value type
0	65535	-	Min Period (ID=10150) Min Angle (ID=10152)	U32

6.6.4.3 Min Angle (ID=10152)

This parameter indicates angle in degrees in order to acquire new record. If angle difference between last recorded coordinate and current position is greater than defined value, new record is stored. This parameter is operational, when speed is higher than 10km/h. If value is 0 it means no records by min angle will be saved.

Minimum value	Maximum value	Recommended value	Goes with (depends on) parameters	Value type
0	180	-	Min Period (ID=10150)	U16

6.6.4.4 Min Speed (ID=10153)

This parameter indicates speed difference in order to acquire new record. If speed difference between last recorded coordinate and current position is greater than defined value, new record is stored. If value is 0 it means no records by min distance will be saved.

Minimum	Maximum	Recommended	Goes with (depends on)	Value
---------	---------	-------------	------------------------	-------

value	value	value	parameters	type
0	255	10	Min Period (ID=10150) Min Distance (ID=10151) Min Angle (ID=10152)	U16

6.6.4.5 Min Saved Records (ID=10154)

This parameter defines minimum number of records in one data packet that can be sent to server. It has higher priority than Data Send Period (ID=10105).

Minimum value	Maximum value	Recommended value	Goes with (depends on) parameters	Value type
1	255	1		U8

6.6.4.6 Send Period (ID=10155)

This parameter indicates frequency (time interval in seconds) of sending data to server.

Minimum value	Maximum value	Recommended value	Goes with (depends on) parameters	Value type
0	2592000	-	Min Saved Records (ID=10104)	U32

6.6.5 Unknown Network GSM operator code "Vehicle on STOP" parameters

6.6.5.1 Min Period (ID=10200)

This parameter indicates time interval in seconds in order to acquire new record. If value is 0 it means no records by min period will be saved.

Minimum value	Maximum value	Recommended value	Goes with (depends on) parameters	Value type
0	2592000	-		U32

6.6.5.2 Min Saved Records (ID=10204)

This parameter defines minimum number of records in one data packet that can be sent to server. It has higher priority than Data Send Period (ID=10205).

Minimum value	Maximum value	Recommended value	Goes with (depends on) parameters	Value type
1	255	1		U8

6.6.5.3 Send Period (ID=10205)

This parameter indicates frequency (time interval in seconds) of sending data to server.

Minimum value	Maximum value	Recommended value	Goes with (depends on) parameters	Value type
0	2592000	-	Min Saved Records (ID=10204)	U32

6.6.6 Unknown Network GSM operator code “Vehicle MOVING” parameters

6.6.6.1 Min Period (ID=10250)

This parameter indicates time interval in seconds in order to acquire new record. If value is 0 it means no records by min period will be saved.

Minimum value	Maximum value	Recommended value	Goes with (depends on) parameters	Value type
0	2592000	-	Min Distance (ID=10151) Min Angle (ID=10152)	U32

6.6.6.2 Min Distance (ID=10251)

This parameter indicates distance in meters in order to acquire new record. Record is stored when the distance between previous records is greater than parameter’s value. If value is 0 it means no records by min distance will be saved.

Minimum value	Maximum value	Recommended value	Goes with (depends on) parameters	Value type
0	65535	-	Min Period (ID=10150) Min Angle (ID=10152)	U32

6.6.6.3 Min Angle (ID=10252)

This parameter indicates angle in degrees in order to acquire new record. If angle difference between last recorded coordinate and current position is greater than defined value, new record is stored. This parameter is operational, when speed is higher than 10km/h. If value is 0 it means no records by min angle will be saved.

Minimum value	Maximum value	Recommended value	Goes with (depends on) parameters	Value type
0	180	-	Min Period (ID=10150)	U16

6.6.6.4 Min Speed (ID=10253)

This parameter indicates speed difference in order to acquire new record. If speed difference between last recorded coordinate and current position is greater than defined value, new record is stored. If value is 0 it means no records by min distance will be saved.

Minimum value	Maximum value	Recommended value	Goes with (depends on) parameters	Value type
0	255	10	Min Period (ID=10150) Min Distance (ID=10151) Min Angle (ID=10152)	U16

6.6.6.5 Min Saved Records (ID=10254)

This parameter defines minimum number of records in one data packet that can be sent to server. It has higher priority than Data Send Period (ID=10105).

Minimum	Maximum	Recommended	Goes with (depends on)	Value

value	value	value	parameters	type
1	255	1		U8

6.6.6.6 Send Period (ID=10255)

This parameter indicates frequency (time interval in seconds) of sending data to server.

Minimum value	Maximum value	Recommended value	Goes with (depends on) parameters	Value type
0	2592000	-	Min Saved Records (ID=10254)	U32

6.7 Features Parameters

6.7.1 Green driving priority (ID=11000)

Defines priority of green driving scenario:

0 – disabled, 1 – low, 2 – high, 3 – panic

Minimum value	Maximum value	Recommended value	Goes with (depends on) parameters	Value type
0	3	-		U8

6.7.2 Max Acceleration Force (ID=11004)

It is max allowed acceleration force which can be reached while accelerating without triggering harsh acceleration event.

Minimum value	Maximum value	Recommended value	Goes with (depends on) parameters	Value type
0.5	10	2.2		Float

6.7.3 Max Braking Force (ID=11005)

It is max allowed braking force which can be reached while braking without triggering harsh braking event.

Minimum value	Maximum value	Recommended value	Goes with (depends on) parameters	Value type
0.5	10	2.5		Float

6.7.4 Max Cornering (ID=11006)

It is max allowed cornering angle which can be reached while cornering without triggering harsh cornering event.

Minimum value	Maximum value	Recommended value	Goes with (depends on) parameters	Value type
0.5	10	2.1		U16

6.7.5 Green/Eco driving (ID=11007)

Choose between Eco driving(accelerometer) and Green driving(gps). 0 – GPS, 1 – Accelerometer

Minimum value	Maximum value	Default value	Goes with (depends on) parameters	Value type

0	1	0		U16
---	---	---	--	-----

6.7.6 Green driving digital output control settings (ID=11003)

Sets digital output off (0) or on (1)

Minimum value	Maximum value	Recommended value	Goes with (depends on) parameters	Value type
0	1	0		Float

6.7.7 Green driving Digital output on duration (ID=11001)

Output ON duration in mili-seconds

Minimum value	Maximum value	default value	Goes with (depends on) parameters	Value type
0	2147483647	200		Float

6.7.8 Green driving Digital output off duration (ID=11002)

Output OFF duration in in mili-seconds

Minimum value	Maximum value	default value	Goes with (depends on) parameters	Value type
0	2147483647	200		Float

6.7.9 Overspeeding priority (ID=11100)

Defines priority of overspeeding scenario:

0 – disabled, 1 – low, 2 – high, 3 – panic

Minimum value	Maximum value	Recommended value	Goes with (depends on) parameters	Value type
0	3	-		U8

6.7.10 Max allowed Speed (ID=11104)

It is max allowed speed which can be reached. If this value exceeded Over speeding event will occur.

Minimum value	Maximum value	Recommended value	Goes with (depends on) parameters	Value type
0	260	-		U16

6.7.11 Overspeeding output control (ID=11103)

Enables (1) or disables (0) overspeeding output control

Minimum value	Maximum value	Recommended value	Goes with (depends on) parameters	Value type
0	1	0		Float

6.7.12 Overspeeding Digital output on duration (ID=11101)

Output ON duration in mili-seconds

Minimum value	Maximum value	Default value	Goes with (depends on) parameters	Value type
0	2147483647	200		U8

6.7.13 Overspeeding Digital output off duration (ID=11102)

Output OFF duration in mili-seconds

Minimum value	Maximum value	Default value	Goes with (depends on) parameters	Value type
0	2147483647	200		U8

6.7.14 Excessive idling priority (ID=11200)

Defines priority of Excessive idling scenario:

0 – disabled, 1 – low, 2 – high, 3 – panic

Minimum value	Maximum value	Recommended value	Goes with (depends on) parameters	Value type
0	3	-		U8

6.7.15 Eventual records (ID=11203)

Disables (0) or enables (1) eventual records with idling value

Minimum value	Maximum value	Recommended value	Goes with (depends on) parameters	Value type
0	1	-		U16

6.7.16 Excessive idling minimum stop duration (ID=11205)

Defines minimum time in seconds of vehicle idling before scenario enables.

Minimum value	Maximum value	Default value	Goes with (depends on) parameters	Value type
0	255	5		Float

6.7.17 Excessive idling minimum move duration (ID=11206)

Defines minimum time in seconds of vehicle idling before scenario disables.

Minimum value	Maximum value	Default value	Goes with (depends on) parameters	Value type
0	255	2		Float

6.7.18 Excessive idling output control (ID=11204)

Enables (1) or disables (0) Excessive idling output control

Minimum value	Maximum value	Recommended value	Goes with (depends on) parameters	Value type
0	1	0		U16

6.7.19 Excessive idling output on duration (ID=11201)

Output ON duration in seconds

Minimum value	Maximum value	Default value	Goes with (depends on) parameters	Value type
0	2147483647	0		Float

6.7.20 Excessive idling output off duration (ID=11202)

Output OFF duration in seconds

Minimum value	Maximum value	Default value	Goes with (depends on) parameters	Value type
0	2147483647	0		Float

6.7.21 Send sms to (ID=7064)

Enable/disable sms event sending. 0 – Disable, 1-10 – sms will be sent to configured GSM number. (SMS \ Call Settings -> GSM Predefined Numbers list.)

Minimum value	Maximum value	default value	Goes with (depends on) parameters	Value type
0	10	0		U64

6.7.22 SMS Text (ID=8064)

Configure uplug sms event text here.

Minimum value	Maximum value	default value	Goes with (depends on) parameters	Value type
0	160	0		U64

6.7.23 Jamming (ID=11300)

Scenario settings: 0 – Disable, 1 – Low, 2 – High, 3 – Panic

Minimum value	Maximum value	Default value	Goes with (depends on) parameters	Value type
0	3	0		U8

6.7.24 Jamming Eventual records (ID=11303)

Disables or enables eventual records. 0 – Disable, 1 – Enable

Minimum value	Maximum value	Default value	Goes with (depends on) parameters	Value type
0	1	1		U8

6.7.25 Jamming Output Control (ID=11304)

Defines rather jamming will control digital output or not. 0 – Disable, 1 – Enable.

Minimum value	Maximum value	Default value	Goes with (depends on) parameters	Value type
0	1	0		U8

6.7.26 Jamming DOUT on duration [ms] (ID=11301)

Sets time period, that Dout will be on.

Minimum value	Maximum value	Default value	Goes with (depends on) parameters	Value type
0	21474836 47	200		U8

6.7.27 Jamming DOUT off duration [ms] (ID=11302)

Sets time period, that Dout will be off.

Minimum value	Maximum value	Default value	Goes with (depends on) parameters	Value type
0	21474836 47	200		U8

6.7.28 DOUT control via call (ID=12000)

Disables or enables dout control via call. 0 – Disable, 1 – Enable.

Minimum value	Maximum value	Default value	Goes with (depends on) parameters	Value type
0	1	0		U8

6.7.29 DOUT deactivation settings (ID=12001)

Enables or disables dout deactivation by Din1. 0 – Disable, 1 – Enable.

Minimum value	Maximum value	Default value	Goes with (depends on) parameters	Value type
0	1	0		U8

6.7.30 DOUT duration timeout [s] (ID=12002)

Defines the time that dout will be activated for.

Minimum	Maximum	Default value	Goes with (depends on)	Value

value	value		parameters	type
0	21474836 47	5		U8

6.7.31 Trip priority priority (ID=11800)

Defines priority of trip scenario:

0 – disabled, 1 – low, 2 – high, 3 – panic

Minimum value	Maximum value	Default value	Goes with (depends on) parameters	Value type
0	3	0		U8

6.7.32 Start Speed (ID=11803)

This parameter represents speed, which is detected as minimum speed to indicate TRIP START and generate event.

Minimum value	Maximum value	Recommended value	Goes with (depends on) parameters	Value type
0	255	-	Trip (ID=11800)	U8

6.7.33 Ignition Off Timeout (ID=11804)

This parameter represents timeout to wait if ignition is off in order to detect TRIP STOP and generate event.

Minimum value	Maximum value	Recommended value	Goes with (depends on) parameters	Value type
0	65535	-	Trip (ID=11800)	U16

6.7.34 Trip mode (ID=11802)

For this feature I/O ODOMETER must be enabled. If I/O ODOMETER is enabled, and mode is set to Continuous (value 0), TRIP distance is going to be counted till the end of trip, if between records mode is set, ODOMETER will count distance only between two records.

Minimum value	Maximum value	Recommended value	Goes with (depends on) parameters	Value type
0	1	-	Trip (ID=11800)	U8

6.8 AutoGeofencing

6.8.1.1 AutoGeofencing priority (ID=20000)

Defines priority of trip scenario:

0 – disabled, 1 – low, 2 – high, 3 – panic

Minimum value	Maximum value	Recommended value	Goes with (depends on) parameters	Value type
0	3	0		U8

6.8.1.2 Eventual Records (ID=20002)

0 – disable, include parameter to all records, 1 – enable, include parameter to record only if event was generated.

Minimum value	Maximum value	Recommended value	Goes with (depends on) parameters	Value type
0	1	1		U8

6.8.1.3 Activation Timeout (ID=20003)

Parameter represents AutoGeofencing activation timeout in seconds.

Minimum value	Maximum value	Recommended value	Goes with (depends on) parameters	Value type
0	65535	60	AutoGeofencing priority (ID=20000)	U16

6.8.1.4 Deactivate by (ID=20005)

Parameter defines Autogeofence deactivation source. Value 0 – for Ignition, - Power Voltage, Digital Input 1

Minimum value	Maximum value	Recommended value	Goes with (depends on) parameters	Value type
0	1	-	AutoGeofencing priority (ID=20000)	U8

6.8.1.5 AutoGeofence event generating (ID=20001)

Generate event: 0 – on exiting zone , 1 – on entering zone; 2 – on both;

Minimum value	Maximum value	Recommended value	Goes with (depends on) parameters	Value type
0	2	0	AutoGeofencing priority (ID=20000)	U8

6.8.1.6 Radius (ID=20004)

Parameter represents radius of circle with center device coordinates after activating AutoGeofence feature.

Minimum value	Maximum value	Recommended value	Goes with (depends on) parameters	Value type
0	1000000	100	AutoGeofencing priority (ID=20000) Deactivate by (ID=20005)	U32

6.8.1.7 Send sms to (ID=7061)

Enable/disable sms event sending. 0 – Disable, 1-10 – sms will be sent to configured GSM number. (SMS \ Call Settings -> GSM Predefined Numbers list.)

Minimum value	Maximum value	default value	Goes with (depends on) parameters	Value type
0	10	0		U64

6.8.1.8 SMS Text (ID=8061)

Configure uplug sms event text here.

Minimum value	Maximum value	default value	Goes with (depends on) parameters	Value type
0	160	0		U64

6.9 GPS Fuel counter

6.9.1.1 City Consumption L/100km (ID=11900)

Consumption in the city

Minimum value	Maximum value	Default value	Goes with (depends on) parameters	Value type
0	50	0		Double

6.9.1.2 Highway Consumption L/100km (ID=11901)

Consumption on highway

Minimum value	Maximum value	Default value	Goes with (depends on) parameters	Value type
0	50	0		Double

6.9.1.3 Average Consumption L/100km (ID=11902)

Average fuel consumption of the vehicle

Minimum value	Maximum value	Default value	Goes with (depends on) parameters	Value type
0	50	0		Double

6.9.1.4 City Speed [km/h] (ID=11903)

Speed in the city

Minimum value	Maximum value	Default value	Goes with (depends on) parameters	Value type
0	250	30		Unit64

6.9.1.5 Highway Speed [km/h] (ID=11904)

Speed on highway

Minimum value	Maximum value	Default value	Goes with (depends on) parameters	Value type
0	250	90		Unit64

6.9.1.6 Average Speed [km/h] (ID=11905)

Average speed of the vehicle

Minimum value	Maximum value	Default value	Goes with (depends on) parameters	Value type
0	250	60		Unit64

6.9.1.7 Correction coefficient (ID=11906)

Sets the correction coefficient

Minimum value	Maximum value	Default value	Goes with (depends on) parameters	Value type
0.01	2	1		Double

6.9.1.8 Fuel Consumption on Idling [L/h] (ID=11907)

Sets fuel consumption while vehicle is idling

Minimum value	Maximum value	Default value	Goes with (depends on) parameters	Value type
0	5	1		Double

6.9.1.9 Higher Speeds Add [%] (ID=11908)

Minimum value	Maximum value	Default value	Goes with (depends on) parameters	Value type
0	250	20		Unit64

6.9.1.10 Highway Consumption every km/h (ID=11909)

Minimum value	Maximum value	Default value	Goes with (depends on) parameters	Value type
0	100	50		Unit64

6.10 Scenarios Accelerometer

6.10.1 Towing Detection

6.10.1.1 Scenario setting (ID=11600)

0 – disabled, 1 – low, 2 – high, 3 – panic

Minimum value	Maximum value	default value	Goes with (depends on) parameters	Value type
0	3	0		U64

6.10.1.2 Eventual Records (ID=11601)

Generate event: 0 – disable; 1 – enable.

Minimum value	Maximum value	default value	Goes with (depends on) parameters	Value type
0	1	1		U64

6.10.1.3 Activation Timeout (min) (ID=11602)

Activation timeout is time after which FM turns ON Towing detection function if other requirement is met (Ignition OFF state detected).

Minimum value	Maximum value	default value	Goes with (depends on) parameters	Value type
0	65535	5		U64

6.10.1.4 Event Timeout (s) (ID=11603)

Defines time period (in second) to check ignition state when Acceleration or Angle value reach. If towing event is generated during this time period, it is skipped. It allows to filter out redundant towing event while entering car.

Minimum value	Maximum value	default value	Goes with (depends on) parameters	Value type
0	60	0		U64

6.10.1.5 Make Call(Sms Event Number ID) (ID=11604)

If function enabled makes call to specified phone number (configured in pre defined numbers).

Minimum value	Maximum value	default value	Goes with (depends on) parameters	Value type
0	-	-		U64

6.10.1.6 Treshold (mg) (ID=11605)

Value used to detect towing when ignition is OFF.

Minimum value	Maximum value	default value	Goes with (depends on) parameters	Value type
0.18	5	0.22		Double

6.10.1.7 Angle (deg) (ID=11606)

Value used to detect towing when ignition is OFF.

Minimum value	Maximum value	default value	Goes with (depends on) parameters	Value type
0.5	5	1		Double

6.10.1.8 Duration (msec) (ID=11607)

Defines time period to check Acceleration, angle values.

Minimum value	Maximum value	default value	Goes with (depends on) parameters	Value type
100	5000	1000		U64

6.10.1.9 Send SMS (ID=7066)

Enable/disable sms event sending. 0 – Disable, 1-10 – sms will be sent to configured GSM number. (SMS \ Call Settings -> GSM Predefined Numbers list.)

Minimum value	Maximum value	default value	Goes with (depends on) parameters	Value type
0	10	0		U64

6.10.1.10 SMS Text (ID=8066)

Configure uplug sms event text here.

Minimum value	Maximum value	default value	Goes with (depends on) parameters	Value type
0	160	0		String

6.10.2 Crash Detection

6.10.2.1 Scenario settings (ID=11400)

Sets priority of the scenario: 0 – Disable, 1 – Low Priority, 2 – High Priority, 3 – Panic Priority

Minimum value	Maximum value	default value	Goes with (depends on) parameters	Value type
0	3	0		U64

6.10.2.2 Duration [ms] (ID=11401)

Minimum value	Maximum value	default value	Goes with (depends on) parameters	Value type
0	1000	5		U64

6.10.2.3 Treshold [mG] (ID=11402)

Minimum value	Maximum value	default value	Goes with (depends on) parameters	Value type
0	7900	1500		U64

6.10.2.4 Crash trace (ID=11406)

Minimum value	Maximum value	default value	Goes with (depends on) parameters	Value type
0	1	0		U64

6.10.2.5 Send sms to (ID=7068)

Enable/disable sms event sending. 0 – Disable, 1-10 – sms will be sent to configured GSM number. (SMS \ Call Settings -> GSM Predefined Numbers list.)

Minimum value	Maximum value	default value	Goes with (depends on) parameters	Value type
0	10	0		U64

6.10.2.6 SMS Text (ID=8068)

Configure uplug sms event text here.

Minimum value	Maximum value	default value	Goes with (depends on) parameters	Value type
0	160	0		U64

6.11 Bluetooth

6.11.1.1 BT Radio (ID=800)

Enables or disable Bluetooth feature. 0 – Disabled, 1 – Enable hidden, 2 – Enable visible

Minimum value	Maximum value	default value	Goes with (depends on) parameters	Value type
0	2	0		U64

6.11.1.2 Local name (ID 801)

Parameter defines a visible name of FMBX device.

Minimum value	Maximum value	default value	Goes with (depends on) parameters	Value type
0 Symbols	30 Symbols	-		String

6.11.1.3 Local PIN (ID=802)

Parameter Lets to configure Bluetooth PIN.

Minimum value	Maximum value	default value	Goes with (depends on) parameters	Value type
0 Symbols	4 Symbols	5555		String

6.11.1.4 Security mode (ID=803)

Parameter defines a security mode of FMBX device. 0 – PIN only, 1 – PIN and MAC, 2 – MAC only, 3 – None.

Minimum value	Maximum value	default value	Goes with (depends on) parameters	Value type
0	3	0		U64

6.11.1.5 External MAC (ID=804)

Defines external device's MAC, for FMB900 to auto connect to.

Minimum value	Maximum value	default value	Goes with (depends on) parameters	Value type
0 symbols	12 symbols	0		string

6.11.1.6 External name (ID=805)

Defines external device's name, for FMB900 to auto connect to.

Minimum value	Maximum value	default value	Goes with (depends on) parameters	Value type
0 symbols	30 symbols	0		string

6.11.1.7 External PIN (ID=806)

Defines external device's PIN, for FMB900 to auto connect to.

Minimum value	Maximum value	default value	Goes with (depends on) parameters	Value type
0 symbols	8 symbols	0		string

6.11.1.8 Connection mode (ID=807)

Defines a mode in which FMB900 will connect to external devices. 0 – None,

1 – FMB900 will connect to Hands Free Headset, 2 – FMB900 will connect to OBDII

Bluetooth dongle.

Minimum value	Maximum value	default value	Goes with (depends on) parameters	Value type
0	2	0		U64

6.11.1.9 Authorized devices MAC list (ID=830 - 834)

Parameter allows to add an authorized devices MAC for connection to FMB900

Minimum value	Maximum value	default value	Goes with (depends on) parameters	Value type
0 symbols	12 symbols	-		String

6.12 I/O parameters

I/O properties are additional data sources which are recorded along with usual GPS data.

6.12.1 I/O#1 property parameter priority Ignition (ID=50000)

Parameter defines I/O property type of priority: 0 is disabled, 1 – low, 2 – high, 3 - panic.

Minimum value	Maximum value	Recommended value	Goes with (depends on) parameters	Value type
0	3	-	I/O#1 priority (ID=50001) I/O#1 High level (ID=50002) I/O#1 Low level (ID=50003) I/O#1 Event only (ID=50004) I/O#1 averaging length (ID=50005)	S8

6.12.2 I/O#1 priority (ID=50001)

Parameter defines when event is sent: 0 – on range exit, 1 – on range entrance, 2 – both, 3 – monitoring, 4 – hysteresis, 5 – on changes, 6 – on delta change.

Minimum value	Maximum value	Recommended value	Goes with (depends on) parameters	Value type
0	6	0	I/O#1 property parameter priority Ignition (ID=50000) I/O#1 High level (ID=50002) I/O#1 Low level (ID=50003) I/O#1 Event only (ID=50004) I/O#1 averaging length (ID=50005)	S8

6.12.3 I/O#1 High level (ID=50002)

Parameter defines high value of triggered I/O property. This parameter is used to set thresholds for I/O properties to generate events.

Minimum value	Maximum value	Recommended value	Goes with (depends on) parameters	Value type
- 21474836 47	214748364 7	1	I/O#1 property parameter priority Ignition (ID=50000) I/O#1 priority (ID=50001) I/O#1 Low level (ID=50003)	S32

			I/O#1 Event only (ID=50004) I/O#1 averaging length (ID=50005)	
--	--	--	--	--

6.12.4 I/O#1 Low level (ID=50003)

Parameter defines low value of triggered I/O property. This parameter is used to set thresholds for I/O properties to generate events.

Minimum value	Maximum value	Recommended value	Goes with (depends on) parameters	Value type
- 21474836 47	214748364 7	0	I/O#1 property parameter priority Ignition (ID=50000) I/O#1 priority (ID=50001) I/O#1 High level (ID=50002) I/O#1 Event only (ID=50004) I/O#1 averaging length (ID=50005)	S32

6.12.5 I/O#1 Event only (ID=50004)

Parameter defines when IO element value is sent: 0 – with every AVL packet, 1 – on event only. On event means that IO element value is included to AVL packet only when this particular event happens. With regular, periodic records such IO element value is not included.

Minimal value	Maximum value	Recommended value	Goes with (depends on) parameters	Value type
0	1	0	I/O#1 property parameter priority Ignition (ID=50000) I/O#1 priority (ID=50001) I/O#1 High level (ID=50002) I/O#1 Low level (ID=50003) I/O#1 averaging length (ID=50005)	S8

6.12.6 I/O#1 averaging length (ID=50005)

Parameter defines I/O property sample length to average. If no averaging needed default value is 1.

Minimum value	Maximum value	Recommended value	Goes with (depends on) parameters	Value type
0	2147483647	10	I/O#1 property parameter priority Ignition (ID=50000) I/O#1 priority (ID=50001) I/O#1 High level (ID=50002) I/O#1 Low level (ID=50003) I/O#1 Event only (ID=50004)	S32

6.13 I/O elements parameters and types.

Priority: 0 – disabled, 1 – low, 2 – high, 3 – panic.

Operand: 0 – On Exit, 1 – On Entrance, 2 – On Both, 3 – Monitoring, 4 – On Hysteresis, 5 – On Change, 6 – On Delta Change.

Event only: 0 – No, 1 – Yes.

Parameter ID	Parameter Type	Default value	Value range		Parameter name
			Min	Max	
50000	Uint8	1	0	3	Ignition Priority
50001	Uint8	5	0	6	Ignition Operand
50002	Uint8	0	0	1	Ignition High level
50003	Uint8	0	0	1	Ignition Low level
50004	Uint8	0	0	1	Ignition Event only
50005	Uint16	10	0	65535	Ignition Average
7000	Uint8	0	0	10	Send SMS
8000	String	0	0	160	SMS Text
50010	Uint8	1	0	3	Movement Priority
50011	Uint8	5	0	6	Movement Operand
50012	Uint8	0	0	1	Movement High level
50013	Uint8	0	0	1	Movement Low level
50014	Uint8	0	0	1	Movement Event only
50015	Uint16	1	0	65535	Movement Average
7001	Uint8	0	0	10	Send SMS
8001	String	0	0	160	SMS Text
50020	Uint8	1	0	3	Data Mode Priority
50021	Uint8	5	0	6	Data Mode Operand
50022	Uint8	0	0	5	Data Mode High level
50023	Uint8	0	0	5	Data Mode Low level
50024	Uint8	0	0	1	Data Mode Event only
7002	Uint8	0	0	10	Send SMS
8002	String	0	0	160	SMS Text
50030	Uint8	1	0	3	GSM Signal Priority
50031	Uint8	5	0	6	GSM Signal Operand
50032	Uint8	0	0	5	GSM Signal High level
50033	Uint8	0	0	5	GSM Signal Low level
50034	Uint8	0	0	1	GSM Signal Event only
50035	Uint16	1	0	65535	GSM Signal Average
7003	Uint8	0	0	10	Send SMS
8003	String	0	0	160	SMS Text
50040	Uint8	1	0	3	Deep Sleep Priority
50041	Uint8	3	0	6	Deep Sleep Operand
50042	Uint8	0	0	2	Deep Sleep High level
50043	Uint8	0	0	2	Deep Sleep Low level
50044	Uint8	0	0	1	Deep Sleep Event only
7004	Uint8	0	0	10	Send SMS
8004	String	0	0	160	SMS Text
50050	Uint8	1	0	3	GNSS Status Priority
50051	Uint8	5	0	6	GNSS Status Operand
50052	Uint8	0	0	1	GNSS Status High level
50053	Uint8	0	0	5	GNSS Status Low level
50053	Uint8	0	0	1	GNSS Status Event only
7005	Uint8	0	0	10	Send SMS

8005	String	0	0	160	SMS Text
50060	Uint8	0	0	3	GNSS PDOP Priority
50061	Uint8	3	0	6	GNSS PDOP Operand
50062	Uint16	0	0	1000	GNSS PDOP High level
50063	Uint16	0	0	1000	GNSS PDOP Low level
50064	Uint8	0	0	1	GNSS PDOP Event only
50065	Uint16	10	0	65535	GNSS PDOP Average
7006	Uint8	0	0	10	Send SMS
8006	String	0	0	160	SMS Text
50070	Uint8	1	0	3	GNSS HDOP Priority
50071	Uint8	3	0	6	GNSS HDOP Operand
50072	Uint16	0	0	1000	GNSS HDOP High level
50073	Uint16	0	0	1000	GNSS HDOP Low level
50074	Uint8	0	0	1	GNSS HDOP Event only
50075	Uint16	10	0	65535	GNSS HDOP Average
7007	Uint8	0	0	10	Send SMS
8007	String	0	0	160	SMS Text
50080	Uint8	1	0	3	External Voltage Priority
50081	Uint8	6	0	6	External Voltage
50082	Uint16	1000	0	60000	External Voltage High
50083	Uint16	0	0	60000	External Voltage Low
50084	Uint8	0	0	1	External Voltage Event
50085	Uint16	10	0	65535	External Voltage Average
7008	Uint8	0	0	10	Send SMS
8008	String	0	0	160	SMS Text
50090	Uint8	1	0	3	Speed Priority
50091	Uint8	3	0	6	Speed Operand
50092	Uint16	0	0	300	Speed High level
50093	Uint16	0	0	300	Speed Low level
50094	Uint8	0	0	1	Speed Event only
50095	Uint16	1	0	65535	Speed Average
7009	Uint8	0	0	10	Send SMS
8009	String	0	0	160	SMS Text
50100	Uint8	0	0	3	GSM Cell ID Priority
50101	Uint8	3	0	6	GSM Cell ID Operand
50102	Uint32	0	0	999999	GSM Cell ID High level
50103	Uint32	0	0	999999	GSM Cell ID Low level
50104	Uint8	0	0	1	GSM Cell ID Event only
7010	Uint8	0	0	10	Send SMS
8010	String	0	0	160	SMS Text
50110	Uint8	0	0	3	GSM Area Code Priority
50111	Uint8	3	0	6	GSM Area Code Operand
50112	Uint32	0	0	999999	GSM Area Code High
50113	Uint32	0	0	999999	GSM Area Code Low
50114	Uint8	0	0	1	GSM Area Code Event
7011	Uint8	0	0	10	Send SMS
8011	String	0	0	160	SMS Text
7013	Uint8	0	0	10	Send SMS

8013	String	0	0	160	SMS Text
50140	Uint8	0	0	3	Active GSM Operator
50141	Uint8	5	0	6	Active GSM Operator
50142	Uint32	0	0	999999	Active GSM Operator
50143	Uint32	0	0	999999	Active GSM Operator
50144	Uint8	0	0	1	Active GSM Operator
7014	Uint8	0	0	10	Send SMS
8014	String	0	0	160	SMS Text
50150	Uint8	0	0	3	Trip Odometer Priority
50151	Uint8	3	0	6	Trip Odometer Operand
50152	Uint32	0	0	1000000	Trip Odometer High
50153	Uint32	0	0	1000000	Trip Odometer Low level
50154	Uint8	0	0	1	Trip Odometer Event
7015	Uint8	0	0	10	Send SMS
8015	String	0	0	160	SMS Text
50160	Uint8	0	0	3	Total Odometer Priority
50161	Uint8	3	0	6	Total Odometer
50162	Uint32	0	0	10000000	Total Odometer High
50163	Uint32	0	0	10000000	Total Odometer Low
50164	Uint8	0	0	1	Total Odometer Event
7016	Uint8	0	0	10	Send SMS
8016	String	0	0	160	SMS Text
50170	Uint8	0	0	3	Digital Input 1 Priority
50171	Uint8	0	0	6	Digital Input 1 Operand
50172	Uint8	0	0	1	Digital Input 1 High
50173	Uint8	0	0	1	Digital Input 1 Low level
50174	Uint8	0	0	1	Digital Input 1 Event only
50175	Uint16	1	0	65535	Digital Input 1 Average
7017	Uint8	0	0	10	Send SMS
8017	String	0	0	160	SMS Text
50180	Uint8	0	0	3	Analog Input 1 Priority
50181	Uint8	6	0	6	Analog Input 1 Operand
50182	Uint16	1000	0	30000	Analog Input 1 High
50183	Uint16	0	0	30000	Analog Input 1 Low level
50184	Uint8	0	0	1	Analog Input 1 Event
50185	Uint16	10	0	65535	Analog Input 1 Average
7018	Uint8	0	0	10	Send SMS
8018	String	0	0	160	SMS Text
50190	Uint8	0	0	3	Digital Output 1 Priority
50191	Uint8	0	0	6	Digital Output 1
50192	Uint8	0	0	1	Digital Output 1 High
50193	Uint8	0	0	1	Digital Output 1 Low
50194	Uint8	0	0	1	Digital Output 1 Event
50195	Uint16	1	0	65535	Digital Output 1 Average
7019	Uint8	0	0	10	Send SMS
8019	String	0	0	160	SMS Text
50200	Uint8	0	0	3	Fuel Used GPS Priority
50201	Uint8	3	0	6	Fuel Used GPS Operand

50202	Uint32	0	0	1000000	Fuel Used GPS Hight
50203	Uint32	0	0	1000000	Fuel Used GPS Low level
50204	Uint8	0	0	1	Fuel Used GPS Event
50205	Uint16	1	0	65535	Fuel Used GPS Average
7020	Uint8	0	0	10	Send SMS
8020	String	0	0	160	SMS Text
50210	Uint8	0	0	3	Fuel Rate GPS Priority
50211	Uint8	3	0	6	Fuel Rate GPS Operand
50212	Uint32	0	0	1000000	Fuel Rate GPS High level
50213	Uint32	0	0	1000000	Fuel Rate GPS Low level
50214	Uint8	0	0	1	Fuel Rate GPS Event only
50215	Uint16	1	0	65535	Fuel Rate GPS Average
7021	Uint8	0	0	10	Send SMS
8021	String	0	0	160	SMS Text
50220	Uint8	0	0	3	Axis X Priority
50221	Uint8	3	0	6	Axis X Operand
50222	Uint16	0	-8000	8000	Axis X Hight level
50223	Uint16	0	-8000	8000	Axis X Low level
50224	Uint8	0	0	1	Axis X Event only
50225	Uint16	1	0	65535	Axis X Average
7022	Uint8	0	0	10	Send SMS
8022	String	0	0	160	SMS Text
50230	Uint8	0	0	3	Axis Y Priority
50231	Uint8	3	0	6	Axis Y Operand
50232	Uint16	0	-8000	8000	Axis Y Hight level
50233	Uint16	0	-8000	8000	Axis Y Low level
50234	Uint8	0	0	1	Axis Y Event only
50235	Uint16	1	0	65535	Axis Y Average
7023	Uint8	0	0	10	Send SMS
8023	String	0	0	160	SMS Text
50240	Uint8	0	0	3	Axis Z Priority
50241	Uint8	3	0	6	Axis Z Operand
50242	Uint16	0	-8000	8000	Axis Z Hight level
50243	Uint16	0	-8000	8000	Axis Z Low level
50244	Uint8	0	0	1	Axis Z Event only
50245	Uint16	1	0	65535	Axis Z Average
7024	Uint8	0	0	10	Send SMS
8024	String	0	0	160	SMS Text
50250	Uint8	0	0	3	ICCID Priority
50251	Uint8	3	0	6	ICCID Operand
50252	Uint16	0	0	8000	ICCID High level
50253	Uint16	0	0	8000	ICCID Low level
50254	Uint8	0	0	1	ICCID Event only
7069	Uint8	0	0	10	Send SMS
8069	String	0	0	160	SMS Text
50260	Uint8	0	0	3	SD Status Priority
50261	Uint8	3	0	6	SD Status Operand
50262	Uint16	0	0	8000	SD Status Hight level

50263	Uint16	0	0	8000	SD Status Low level
50264	Uint8	0	0	1	SD Status Event only
7069	Uint8	0	0	10	Send SMS
8069	String	0	0	160	SMS Text



Note: Operand On Delta Change

Record is generated when value changes and absolute value of last value minus actual input value becomes equal or higher than high level value.

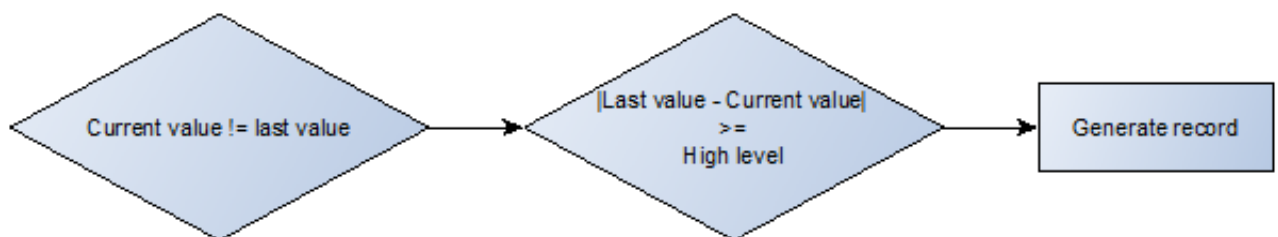

Example: External voltage I/O element.

Low level – Unknown (leave 0)

High level – 1000mV (1V)

Event will occur when the external voltage value changes for 1V and it doesn't matter if value gets higher or lower.

7 MOUNTING RECOMMENDATIONS

7.1 Connecting Wires

- Wires should be fastened to the other wires or non-moving parts. Try to avoid heat emitting and moving objects near the wires.
- The connections should not be seen very clearly. If factory isolation was removed while connecting wires, it should be applied again.
- If the wires are placed in the exterior or in places where they can be damaged or exposed to heat, humidity, dirt, etc., additional isolation should be applied.
- Wires cannot be connected to the board computers or control units.

7.2 Connecting Power Source

- Be sure that after the car computer falls asleep, power is still available on chosen wire. Depending on car, this may happen in 5 to 30 minutes period.
- When module is connected, measure voltage again to make sure it did not decrease.
- It is recommended to connect to the main power cable in the fuse box.
- Use 3A, 125V external fuse.

7.3 Connecting Ignition Wire

- Be sure to check if it is a real ignition wire – power does not disappear while starting the engine.
- Check if this is not an ACC wire (when key is in the first position, most electronics of the vehicle are available).
- Check if power is still available when you turn off any of vehicles devices.
- Ignition is connected to the ignition relay output. As alternative, any other relay, which has power output when ignition is on, may be chosen.

7.4 Connecting Ground Wire

- Ground wire is connected to the vehicle frame or metal parts that are fixed to the frame.
- If the wire is fixed with the bolt, the loop must be connected to the end of the wire.
- For better contact scrub paint from the place where loop is connected.



PAY ATTENTION! Connecting the power supply must be carried out in a very low impedance point of on-board vehicle network. These points in the car are the battery terminals. Therefore, we recommend connecting the power of FMB900 (GND and POWER wires) directly to the battery terminals. Another valid option is to connect the wires to the main POWER cable inside the fuse box (if there is none, then to the power supply where the fuses of vehicle's computer are), GND wire must be connected in a special point, designed to connect GND vehicle computer. Connecting the GND at an arbitrary point to the mass of the car is unacceptable, as static and dynamic potentials on the line GND will be unpredictable, which can lead to unstable FMB900 operation and even its failure.

8 FMB900 installation instruction

FMB900 is the device that has internal GNSS and GSM antenna.

Device should be mounted with the sticker view to the open sky (metal free). FMB900 area with sticker and GNSS antenna is shown in figure 25.



Figure 25 FMB900 view

Most light vehicles has oblique front window that opens most part of interior front panel.

FMB900 can be mounted under the plastic panel behind the front window, with the sticker direction to a window (sky). It is recommended to place FMB900 behind dashboard as close to the window as possible. A good example of GNSS antenna placement is displayed in a picture below (area colored green).

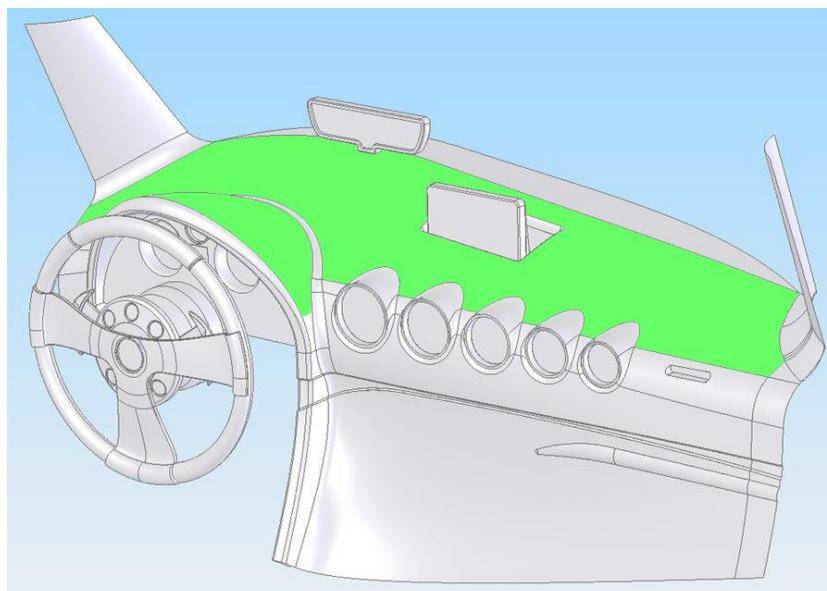

Figure 26 Correct placement of FMB900

9 CHANGE LOG

Nr.	Date	Version	Comments
1	2016-08-25	0.01	Preliminary draft release.
2	2016-10-31	0.02	Preliminary draft release update.
3	2016-11-10	0.03	Preliminary draft release update.
4	2016-11-17	0.04	Removed internal comments.
5	2016-12-06	0.05	Formating changes
6	2016-12-12	0.06	4.4.6 Crash Trace operation updated
7	2016-12-12	0.07	Fixed for LVD certification
8	2016-12-19	0.08	Added Bluetooth connection info. MicroSD insert info. SMS Event Time Zone configuration description. Crash Trace example.
9	2017-01-07	0.09	Added setdigout SMS command explanation.
10	2017-01-09	0.10	Added caution note about DOUT.
11	2017-01-31	0.11	Updated software requirements.
12	2017-02-02	0.12	Added SELV limited power source line.
13	2017-02-15	0.13	Added Towing. Bluetooth description, Dout control via call, GNSS fuel counter, Excessive idling, Eco driving. SMS ID.
14	2017-02-21	0.14	Updated IO elements SMS ID description.
15	2017-03-01	0.15	Deleted "Unplug Detection" description. „Unplug Detection“ work just in device with battery. FMB900 doesn't have battery.
16	2017-03-06	0.16	Correction in setdigout command explanation
17	2017-03-23	0.17	Correction AutoGeofence event generating SMS ID. Added Note: SIM card insertion/removal Added Terminal log description. Added OBD II Bluetooth Dongle description Added Bluetooth Hands Free description Added device debug over Android smartphone
18	2017-03-24	0.18	Added SMS command "btgetlist" description. Added Min Saved Records and Send Period ID
19	2017-03-29	0.19	Correction microSD description Added "\IO elements parameters and types"
20	2017-03-31	0.20	Correction Crash Detection SMS ID Correction "setparam" SMS command description. Correction "Crash Trace" description.
21	2017-04-06	0.21	Correction "Deep Sleep" description. Added LED indicator status description.
22	2017-04-19	0.22	Correction "Technical details" description. Correction "getparam" and "setparam" description. Correction "Green driving" parameters values. Correction "Idling" parameters ID.

			GNSS status IO element Hi Level Max value updated. Added I\O elements ICCID and SD status. Added "Synchronization settings" parameters values.
23	2017-04-27	0.23	Minor changes Correction "AutoGeofencing" parameters values. Added SMS ID "Towing Detection"
24	2017-05-25	0.24	Added Note: Firmware downgrade Added Note: Operand On Delta Change Correction "Green driving" parameters values. Correction "Green driving" description. Added BT "Data Link" description. Correction Value "GSM number index" Correction "getinfo" SMS command description.