

# GPS Tracker ST-906 (ST-906W)

## User Manual



## Quick Start

Thank you for purchasing our GPS tracker.  
This Quick User shows how to operate the device smoothly and correctly.

### WEBSITE Tracking (PC Version):



Platform: [www.sinotracker.com](http://www.sinotracker.com)

User name: ID number on the tracker

Password: 123456

### APPLICATION Tracking (Mobile APP):

You can search **SinoTrack PRO** on APP Store (iOS) or Google Play (Android)  
Or Download from the QR Code:



Server: SinoTracker  
User Name: ID number on tracker  
Password: 123456

If you have more **SinoTrack GPS trackers**, and want to manage them in one account, please contact us, we will create an account for you, so you can monitor **multiple devices** on the platform at the same time.

You can also down load our APPS on website to track on your mobile:

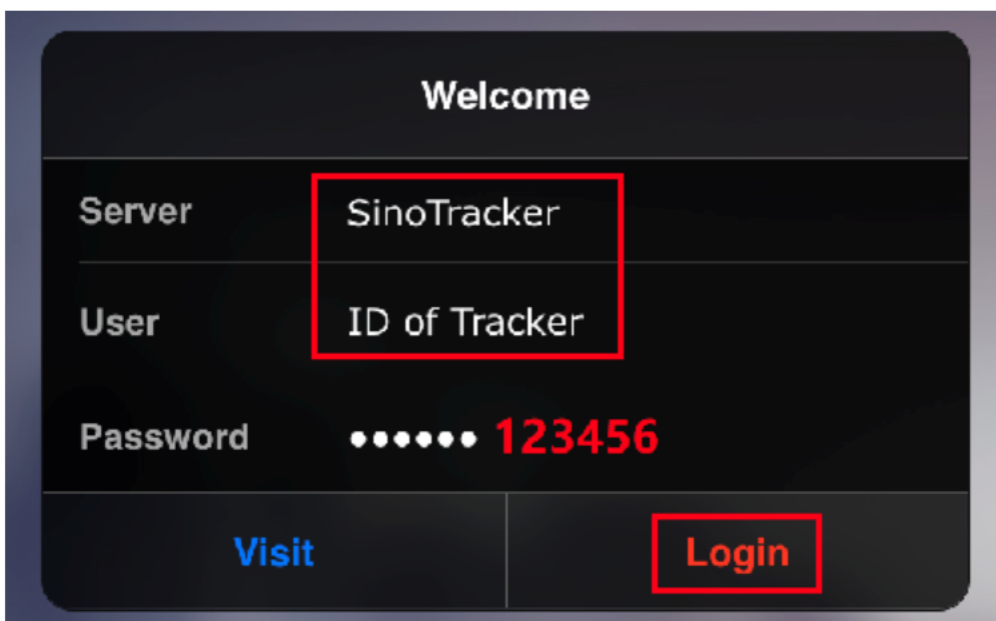

1. Choose GSM card, it should be Normal SIM card, without PIN code.



3. Proper insert GSM card, the tracker will start, connect external power supply.

4. Put device outside around 30s, LED lights will keep lighting on stands for device can work normally.

5. Dialing device number, it will hang up and reply tracking message with valid Lon and lat.

6. Please send SMS to tracker to set the APN: (the yellow place   is BLANK)

SMS: **8030000|APN**

(APN is Access Point Name of your SIM Card, please check with your SIM Card provider if you don't know it)

If the APN need User name and Password, please send the command:

SMS: **8030000|APN|APNuser|APNpassword**

7. Send SMS to set trackers to our server:

SMS: **8040000|45.112.204.217|8090**

8. If you set ok of all, you can track it online.

If the device is not online, please check device setting, send: **RCONF** to device, It will reply the setting.

1. The APN is correct;
2. The IP and Port is correct;
3. The ID on platform is correct;
4. The device working model, (SMS model or GPRS model)

If you need login account or still have problems or any suggestions,

Please leave message under your order,

Or send email to: [sino@sinotrack.com](mailto:sino@sinotrack.com)

For order support, you'd better leave message under your order,

It will be fast to solve your problem, Thanks.

## LED Status

### 1.1. Blue LED--- GPS Status

Status	Meaning
Flashing	No GPS Signal or GPS starting
ON	GPS OK

### 1.2. Orange LED---GSM Status

Status	Meaning
Flashing	No SIM card or GSM starting
ON	GSM OK

### 1.3. Red LED---GSM Status

Status	Meaning
OFF	Tracker is off or sleep
Flashing	Tracker is Working

The default password is: 0000

The default mode is normal working (ACC Mode).

GPS Status: A is get location, V is invalid location.

Alarm mode is on. Alarm will send to the 3 control number.

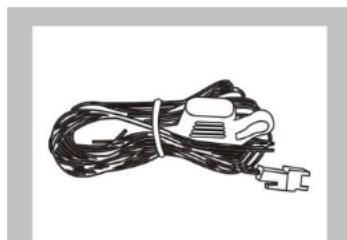

power cord(standard)

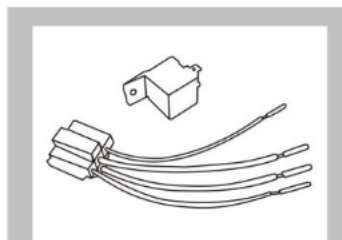

Relay(optional)

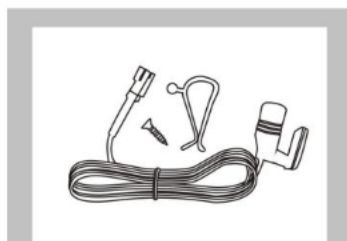

Microphone(optional)

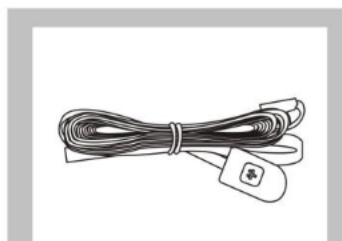

SOS Alarm button  
(optional)

## Installation:

1. **The GPS antenna side should towards to clear sky.  
(Can't put under Metal, but Glass and Plastic is ok)**

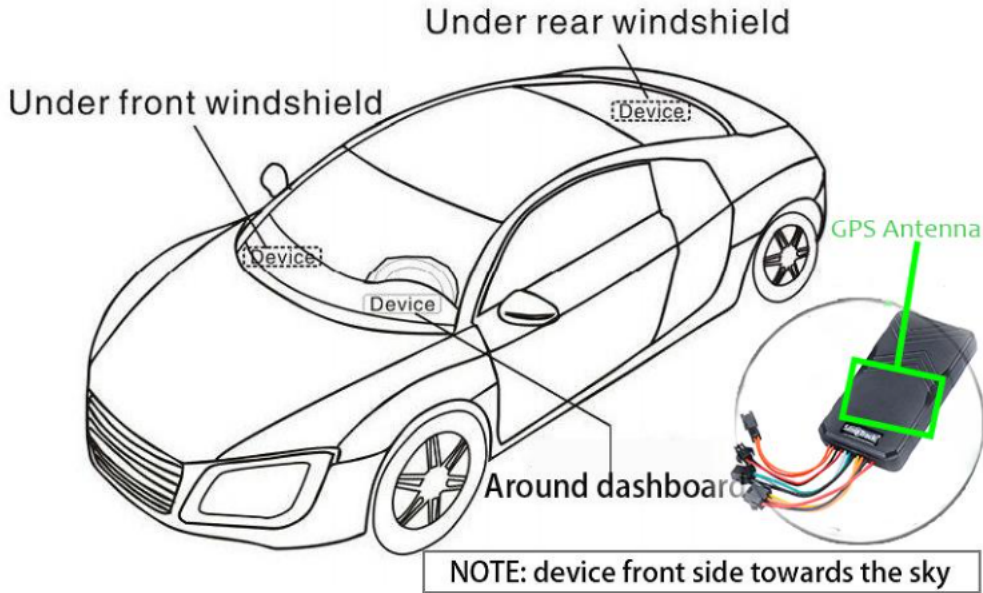

2. **Connect the wires:**

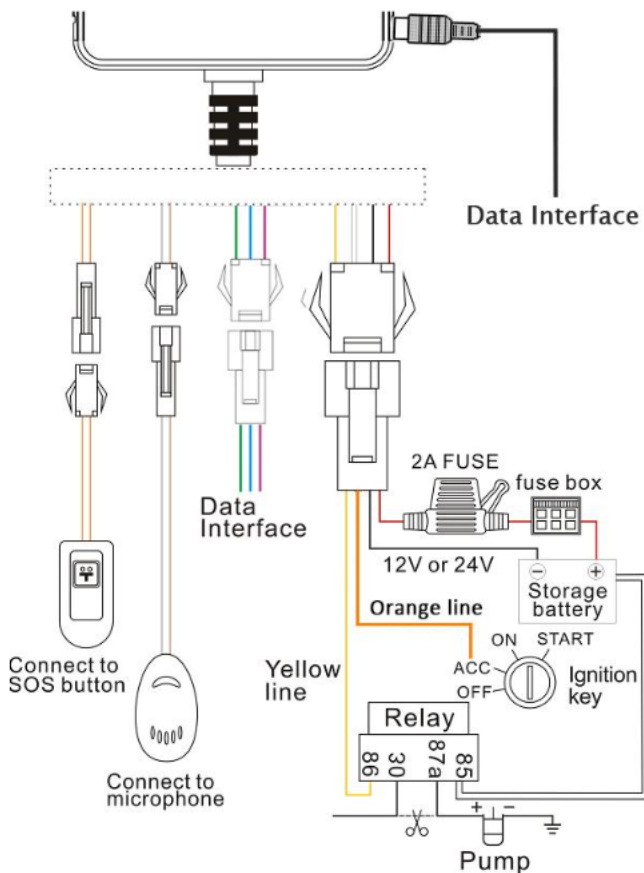

## **Functions:**

### **1. Set control number: (serial from 1 to 3)**

Command: **Number+pass+blank+serial**

Sample: **1395044346500001**

13950443465 is mobile number, 0000 is password, 1 is serial means the first number.

When the tracker reply "SET OK" means the setting is ok.

You can set the second and third control number also.

### **Delete control number:**

**D101#** (delete the first control number)

**D102#** (delete the second control number)

**D103#** (delete the third control number)

## **Monitor:**

Send command **66** to the GPS Tracker from control number,

The tracker will call back to this control number.

## **2. Working mode:**

ST-906 has both SMS and GPRS working mode.

1. If you want to control it by mobile and use SMS only, you can get Google location from you mobile, then you can choose SMS mode.

2. If you want to monitor the tracker online real time, and you want to install the tracker data for years, you should choose the GPRS mode.

You can send SMS to choose the mode.

### **SMS Mode:**

Command: **700+Password**

Sample: **7000000**

Reply: SET OK

When ST-906 receives the command, it will change to SMS mode.

### **GPRS Mode: (Default)**

Command: **710+Password**

Sample: **7100000**

Reply: SET OK

When ST-906 receives the command, it will change to GPRS mode.

## **3. Change Password**

Command: **777+New Password+Old password**

Sample: **77712340000**

The 1234 is new password, and 0000 is old password.

When ST-906 received the command, it will reply SET OK

#### 4. Get location with Google link

Command: **669+password**

Sample: **6690000**

When ST-906 receives the command, it will send back the location with Google link;

You can open the link to check the tracker location on maps.

6690000

[http://maps.google.com/maps?q=+22.64208,+114.18828](http://maps.google.com/maps?q=) Date: 2016-5-18 Time:13:40 ID: 8160528336 Fix:A Speed:0KM/H Bat: 5

#### 5. Get location by phone call.

You can use any mobile to call the SIM Card in tracker, it will reply the location with Google link; you can open the link to check the tracker location on maps.

[http://maps.google.com/maps?q="+22.64207,+114.18829](http://maps.google.com/maps?q=) Date: 2016-5-18 Time:13:36 ID: 8160528336 STATE:Phone ACC OFF Fix:A Speed:0KM/H Bat:5

When you call the tracker when it is in invalid location, it will reply the last valid location to you, after it get new location again, it will send the seconds SMS to you with new location.

#### 6. Change Time Zone

Command: **896+password+Blank+E/W+HH**

Sample: **8960000E00 (default)**

E means East, W means west, 00 mean time zone.

Reply: SET OK

0 time zone is 8960000E00

#### 7. Send location in defined time every day.

It will send to the first control number.

Command: **665+password+HHMM**

HH mean hour, it from 00 to 23,

MM means minutes, it from 00 to 59.

Sample: **66500001219**

Reply: SET OK

Close the function command: **665+password+OFF (default)**

Sample: **6650000OFF**

Reply: SET OK



<http://maps.google.com/maps?q=>  
[+22.64207,+114.18829](http://maps.google.com/maps?q=) Date:  
2016-5-18 Time:13:36 ID:  
8160528336 STATE: DAILY REPORT  
Fix:A Speed:0KM/H Bat:5

## 8. Geo Fence (send alarm to the first number only)

Open Geo Fence: **211+password**

Sample: **2110000**

Reply: SET OK

Close Geo Fence: **210+password**

Sample: **2100000**

Reply: SET OK

Set the Geo Fence

Sample: **0050000|1000 (the Geo Fence is 1000 meters)**

Reply SET OK

We suggest the Geo Fence more than 1000 meters.

<http://maps.google.com/maps?q=>  
[+22.64207,+114.18829](http://maps.google.com/maps?q=) Date:  
2016-5-18 Time:13:36 ID:  
8160528336 STATE: OVER FENCE ALARM  
Fix:A Speed:0KM/H Bat:5

## 9. Over speed Alarm (send Alarm to control numbers)

Command: **122+Blank+XXX**

Sample: **1220000|120**

Reply: SET OK

The XXX is the speed, from 0 to 999, the unit is KM/H.

If the XXX is 0, it means close the over speed alarm.

<http://maps.google.com/maps?q=>  
[+22.64207,+114.18829](http://maps.google.com/maps?q=) Date:  
2016-5-18 Time:13:36 ID:  
8160528336 STATE: OVER SPEED ALARM  
Fix:A Speed:0KM/H Bat:5

## 10. Mileage

### Set the initial Mileage

Command: **142+Password<+M+X>**

X is the initial Mileage, the unit is meter.

Sample: **1420000M1000**

Reply: SET OK, CURRENT: 1000

### Red the current Mileage

Command: **143+password**

Sample: **1430000**

Reply: CURRENT TOTAL MILEAGE:XX.

XX is the mileage, the unit is meter.

### **11. Shock Alarm (send SMS alarm to the first number)**

Open Shock Alarm: **181+password+T**

Sample: **1810000T10**

Reply: SET OK

The T meaning shocking time, the unit is second,  
It from 0 to 120 seconds.

Close Shock Alarm: **180+password**

Sample: **1800000**

Reply: SET OK

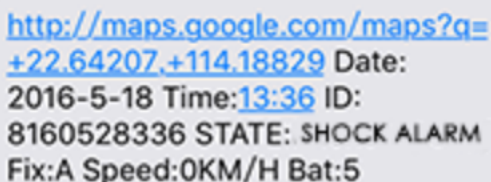

<http://maps.google.com/maps?q=>  
[+22.64207,+114.18829](http://maps.google.com/maps?q=) Date:  
2016-5-18 Time:13:36 ID:  
8160528336 STATE: SHOCK ALARM  
Fix:A Speed:0KM/H Bat:5

### **12. Low battery alarm (send SMS to first number)**

When the battery is low, the tracker will send the Low Power Alarm SMS to the first number

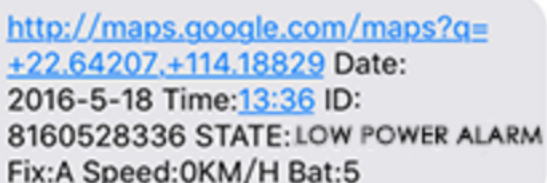

<http://maps.google.com/maps?q=>  
[+22.64207,+114.18829](http://maps.google.com/maps?q=) Date:  
2016-5-18 Time:13:36 ID:  
8160528336 STATE: LOW POWER ALARM  
Fix:A Speed:0KM/H Bat:5

When the battery is full, it is 100%; When the Bat is 20%, it will send low battery alarm.

### **13. Call mode**

Call mode on:

Command: **150+password**

Sample: **1500000**

Reply: SET OK

Call mode off

Command: **151+password**

Sample: **1510000**

Reply: SET OK

When the call mode on, the alarms will call and send SMS to control number,  
When the call mode off, only send SMS.

#### **14. Cut Engine remotely**

**Cut Engine command: 940+password**

Sample: 9400000

After tracker receive command, it will cut engine and send back "SET OK"

**Recover Engine command: 941+password**

After tracker receive command, it will recover engine and send back "SET OK"

#### **15. Set APN**

Command : **803+password+Blank+APN**

Sample: **8030000|CMNET**

Reply: SET OK

If your APN need user and pass:

Command : **803+password+Blank+APN+Blank+APNuser+Blank+APNpass**

Sample: **8030000|CMNET|CMNET|CMNET**

Reply: SET OK

#### **16. Set the IP and Port**

Command: **804+password+Blank+IP+Blank+Port**

Sample: **8040000|45.112.204.217|8090**

Reply: SET OK

#### **17. Set the time interval**

ACC on time interval (**default is 20 seconds**)

Command: **805+password+Blank+T**

Sample: **8050000|20**

Reply: SET OK

T means the time interval, the unit is second,

It from 0 to 18000 seconds,

When T=0 means close GPRS.

ACC off time interval (**default is 300 seconds**)

Command: **809+password+Blank+T**

Sample: **8090000|300**

Reply: SET OK

T means the time interval, the unit is second,

It from 0 to 18000 seconds,

When T=0 means close GPRS.

The minimum time interval is 10 seconds.

# Other Functions:

## 1. RESTART

The tracker will restart.

## 2. RCONF

Read the configure of tracker

Tracker will reply:

**ST901, ID: 8160528336, UP:0000, U1:, U2:, U3:, MODE:GPRS  
DAILY:OFF, GEO FENCE: OFF, OVER SPEED:OFF  
VOICE:ON, SHAKE  
ALARM:OFF, SLEEP:OFF, APN:CMNET,, IP:45.112.204.217:8090, GP  
RSUPLOAD TIME:20  
TIME ZONE:E00**

**ST901:** software version

**ID:** 8160528336 (Tracker ID)

**UP:** 0000 (password, default is 0000)

**U1:** the first control number,

**U2:** the second control number,

**U3:** the third control number.

**MODE:GPRS** (working mode, default is GPRS)

**DAILY:OFF** (Daily time to report, default off)

**GEO FENCE: OFF** (Geo Fence, default off)

**OVER SPEED:OFF** (over speed, default off)

**VOICE:ON** (Call mode, default on)

**SHAKE ALARM:OFF** (Shock Alarm, default off)

**SLEEP MODE : OFF** (sleep mode, default off)

**APN:CMNET,,** (APN, default is CMNET)

**IP:45.112.204.217:8090** (The IP and Port)

**GPRS UPLOAD TIME:20** (time interval)

**TIME ZONE:E00** (Time zone, default is +0)

